

Technical data sheet

CE: Ref 01023191 - UPC/EAN 737859231919
UK: Ref 01023191 - UPC/EAN 737859231919
US: Ref 01023192 - UPC/EAN 737859231919
JP: Ref 01023193 - UPC/EAN 737859231919

Description:

Belle de Nuit - Chandelier 40 lights - white
Belle de Nuit - Chandelier 40 luces - blanco

Collection:

BELLE DE NUIT

Mounting:

Chandelier

Environment:

Chandelier entirely made in porcelain. Made in different finishes to be able to match all decorative ambiances. Not very heavy to make more easy its installation. Bespoke measures under request.

Installation and assembly:

Follow instructions of the installation guide

Electrical characteristics:

Max. Power: 40 x 18W
Tension: CE-UK: 220/240VAC US-JP: 100/125VAC
Frequency: 50/60Hz
 Dimmer not included / LED bulb non dimmable

Recommended Bulb

Bulb not included	Bulb reference
CE: 40 x G9 Led 3W 220V (190Lm)	01089407
US: 40 x G9 Led 3W 110V (190Lm)	

Certificates:

CE, SASO
UL

Physical characteristics:

1 Box / 202,67 x 100 x 100 cm / 2,027 m3
 1 Box / 79 3/4 x 39 1/4 x 39 1/4 inches / 122860 in3
 Gross weight 129,6 kg. / Net weight 27,4 kg.



LLADRÓ BdN - Chand.
 Esta luminaria es compatible con bombillas de clases energéticas:
 A++
 A+
 A
 B
 C
 D
 E
 874/2012



Sketch

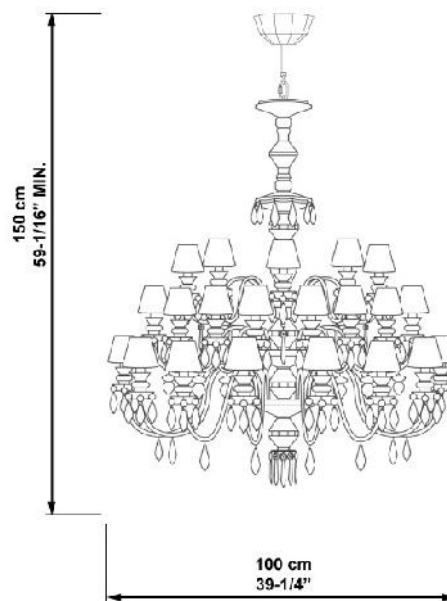

Technical data sheet

CE: Ref 01023214 - UPC/EAN 737859232145
UK: Ref 01023214 - UPC/EAN 737859232145
US: Ref 01023215 - UPC/EAN 737859232145
JP: Ref 01023216 - UPC/EAN 737859232145

Description:

Belle de Nuit - Chandelier 24 lights - black
Belle de Nuit - Chandelier 24 luces - negro

Collection:

BELLE DE NUIT

Mounting:

Chandelier

Environment:

Chandelier entirely made of porcelain. Made in different finishes to match all decorative ambiences. Not very heavy to simplify its installation. Bespoke measures available under request.

Installation and assembly:

Follow instructions of the installation guide

Electrical characteristics:

Max. Power: 24 X 18W
Tension: CE-UK: 220/240VAC US-JP: 100/125VAC
Frequency: 50/60Hz
 Dimmer not included / LED bulb non dimmable

Recommended Bulb

Bulb not included	Bulb reference
CE: 24 x G9 Led 3W 220V (190Lm)	01089407
US: 24 x G9 Led 3W 110V (190Lm)	

Certificates:

CE, SASO
UL

Physical characteristics:

1 Box / 151,487 x 100 x 100 cm / 1,515 m3
 1 Box / 59 3/4 x 39 1/4 x 39 1/4 inches / 92049 in3
 Gross weight 44,1 kg. / Net weight 21,2 kg.

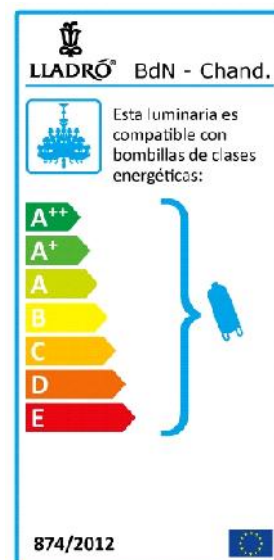

Sketch

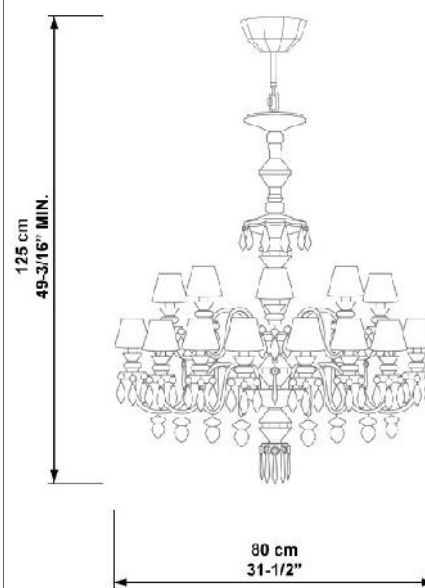

Technical data sheet

CE: Ref 01023217 - UPC/EAN 737859232176
UK: Ref 01023217 - UPC/EAN 737859232176
US: Ref 01023218 - UPC/EAN 737859232176
JP: Ref 01023219 - UPC/EAN 737859232176

Description:

Belle de Nuit - Wall 2 lights - black
Belle de Nuit - Aplique pared 2 luces - negro

Collection:

BELLE DE NUIT

Mounting:

Wall light

Environment:

Wall lamp made of porcelain with decorative back mirror to enhance light effect. Made in different finishes to match all decorative ambiances. Easy to fit for a fast installation. Bespoke measures available under request.

Installation and assembly:

Follow instructions of the installation guide

Electrical characteristics:

Max. Power: 2 X 18W
Tension: CE-UK: 220/240VAC US-JP: 100/125VAC
Frequency: 50/60Hz
 Dimmer not included / LED bulb non dimmable

Recommended Bulb

Bulb not included	Bulb reference
CE: 2 x G9 Led 3W 220V (190Lm)	01089407
US: 2 x G9 Led 3W 110V (190Lm)	

Certificates:

CE, SASO

Physical characteristics:

1 Box / 4,856 x 100 x 100 cm / 0,049 m3
 1 Box / 2 x 39 1/4 x 39 1/4 inches / 3081 in3
 Gross weight 3,1 kg. / Net weight 1,8 kg.

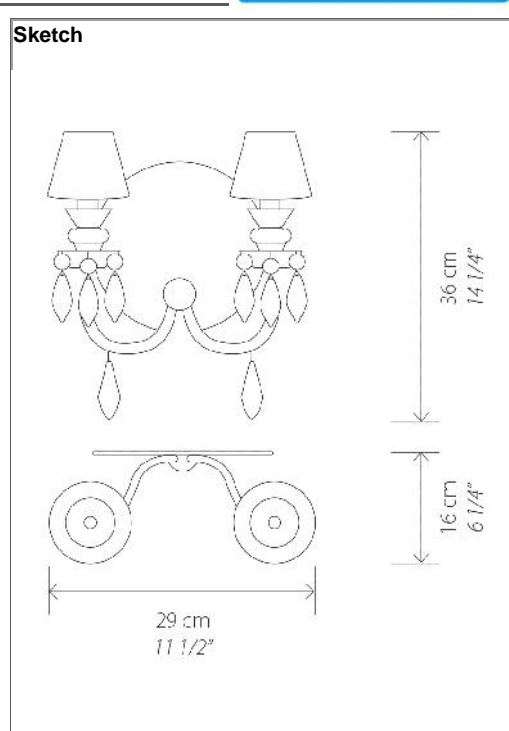

Technical data sheet

CE: Ref 01023220 - UPC/EAN 737859232206
UK: Ref 01023221 - UPC/EAN 737859232206
US: Ref 01023222 - UPC/EAN 737859232206
JP: Ref 01023223 - UPC/EAN 737859232206

Description:

Belle de Nuit - Table Lamp - black
Belle de Nuit - Lámpara de sobremesa - negro

Collection:

BELLE DE NUIT

Mounting:

Table lamp

Environment:

Table lamp body in porcelain. Available in different finishes to match all decorative ambiances

Installation and assembly:

Follow instructions of the installation guide

Electrical characteristics:

Max. Power: 1 x 18W
Tension: CE-UK: 220/240VAC US-JP: 100/125VAC
Frequency: 50/60Hz
 Dimmer not included

Recommended Bulb

Bulb not included	Bulb reference
CE: 1 x E27 LED 6W (600 Lm)	01089432
US: 1 x E26 LED 6W (600 Lm)	

Certificates:

CE, SASO
UL

Physical characteristics:

1 Box / 49,7 x 32,3 x 56,8 cm / 0,091 m3
 1 Box / 19 1/2 x 12 3/4 x 22 1/4 inches / 5532 in3
 Gross weight 3,3 kg. / Net weight 1,3 kg.

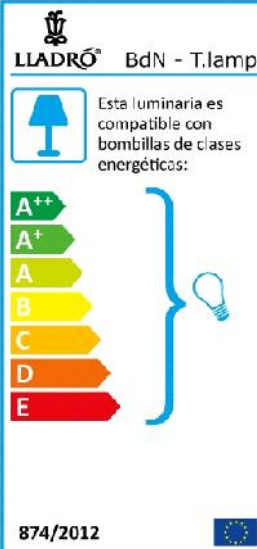
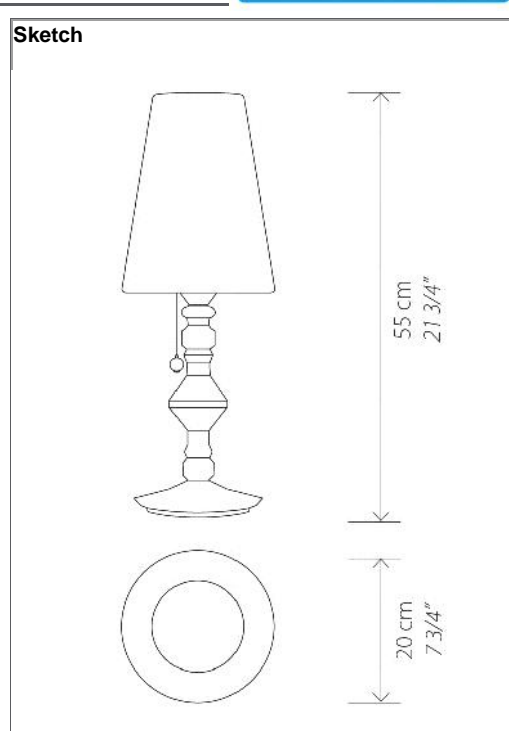
Technical data sheet

CE: Ref 01023224 - UPC/EAN 737859232244
UK: Ref 01023225 - UPC/EAN 737859232244
US: Ref 01023226 - UPC/EAN 737859232244
JP: Ref 01023227 - UPC/EAN 737859232244

Description:

Belle de Nuit - Lithophane Table Lamp - black
Belle de Nuit - Lámpara de sobremesa con Litofanía - negro

Collection:

BELLE DE NUIT

Mounting:

Table lamp

Environment:

Both lamp body and lampshade are made of porcelain. Available in different finishes to match all decorative ambiances.

Installation and assembly:

Follow instructions of the installation guide

Electrical characteristics:

Max. Power: 1 x 18W
Tension: CE-UK: 220/240VAC US-JP: 100/125VAC
Frequency: 50/60Hz
 Dimmer not included / LED bulb non dimmable

Recommended Bulb

	Bulb reference
Bulb not included	
CE: 1 x G9 Led 3W 220V (190Lm)	01089407
US: 1 x E12 Dimmable candle Led 4W	

Certificates:

CE, SASO
UL

Physical characteristics:

1 Box / 17,9 x 24,9 x 42,3 cm / 0,019 m3
 1 Box / 7 x 9 3/4 x 16 3/4 inches / 1143 in3
 Gross weight 1,4 kg. / Net weight 0,7 kg.



Sketch

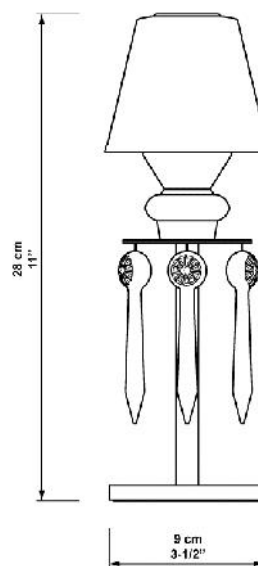

Technical data sheet

CE:	Ref 01023228 - UPC/EAN 737859232282
UK:	Ref 01023228 - UPC/EAN 737859232282
US:	Ref 01023229 - UPC/EAN 737859232282
JP:	Ref 01023230 - UPC/EAN 737859232282

Description:

Belle de Nuit - Chandelier 12 lights - green
Belle de Nuit - Chandelier 12 luces - verde

Collection:

BELLE DE NUIT

Mounting:

Chandelier

Environment:

Chandelier entirely made of porcelain. Made in different finishes to match all decorative ambiences. Not very heavy to simplify its installation. Bespoke measures available under request.

Installation and assembly:

Follow instructions of the installation guide

Electrical characteristics:

Max. Power: 12 x 18W
Tension: CE-UK: 220/240VAC US-JP: 100/125VAC
Frequency: 50/60Hz
Dimmer not included / LED bulb non dimmable

Recommended Bulb

Bulb not included	Bulb reference
CE: 12 x G9 Led 3W 220V (190Lm)	01089407
US: 12 x G9 Led 3W 110V (190Lm)	

Certificates:

CE, SASO
UL

Physical characteristics:

1 Box / 111 x 82 x 82 cm / 0,746 m3
1 Box / 43 3/4 x 32 1/4 x 32 1/4 inches / 45503 in3
Gross weight 36 Kg. / Net weight 8,3 Kg.



Sketch

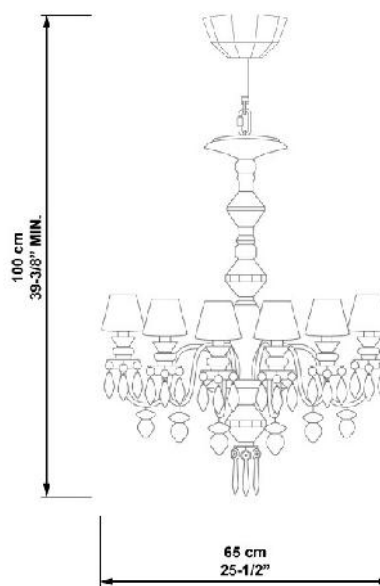

Technical data sheet

CE: Ref 01023231 - UPC/EAN 737859232312
UK: Ref 01023231 - UPC/EAN 737859232312
US: Ref 01023232 - UPC/EAN 737859232312
JP: Ref 01023233 - UPC/EAN 737859232312

Description:

Belle de Nuit - Chandelier 40 lights - green
Belle de Nuit - Chandelier 40 luces - verde

Collection:

BELLE DE NUIT

Mounting:

Chandelier

Environment:

Chandelier entirely made of porcelain. Made in different finishes to match all decorative ambiances. Not very heavy to simplify its installation. Bespoke measures available under request.

Installation and assembly:

Follow instructions of the installation guide

Electrical characteristics:

Max. Power: 40 x 18W
Tension: CE-UK: 220/240VAC US-JP: 100/125VAC
Frequency: 50/60Hz
 Dimmer not included / LED bulb non dimmable

Recommended Bulb

Bulb not included	Bulb reference
CE: 40 x G9 Led 3W 220V (190Lm)	01089407
US: 40 x G9 Led 3W 110V (190Lm)	

Certificates:

CE, SASO
UL

Physical characteristics:

1 Box / 140 x 119 x 119 cm / 1,983 m³
 1 Box / 55 x 46 3/4 x 46 3/4 inches / 120206 in³
 Gross weight 129,6 kg. / Net weight 27,4 kg.



Sketch

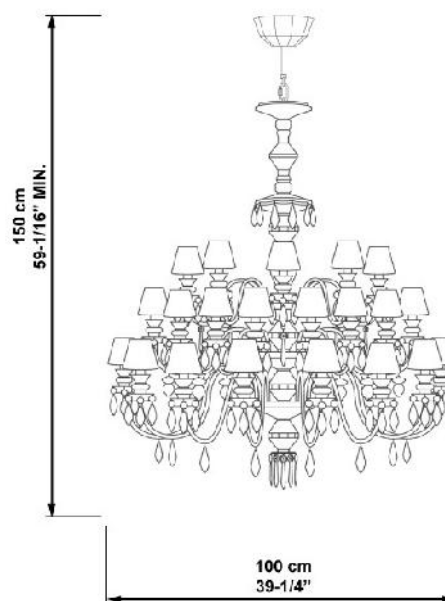

Technical data sheet

CE: Ref 01023234 - UPC/EAN 737859232343
UK: Ref 01023234 - UPC/EAN 737859232343
US: Ref 01023235 - UPC/EAN 737859232343
JP: Ref 01023236 - UPC/EAN 737859232343

Description:

Belle de Nuit -Chandelier 24 lights - green
Belle de Nuit - Chandelier 24 luces - verde

Collection:

BELLE DE NUIT

Mounting:

Chandelier

Environment:

Chandelier entirely made of porcelain. Made in different finishes to match all decorative ambiences. Not very heavy to simplify its installation. Bespoke measures available under request.

Installation and assembly:

Follow instructions of the installation guide

Electrical characteristics:

Max. Power: 24 x 18W
Tension: CE-UK: 220/240VAC US-JP: 100/125VAC
Frequency: 50/60Hz
 Dimmer not included / LED bulb non dimmable

Recommended Bulb

Bulb not included	Bulb reference
CE: 24 x G9 Led 3W 220V (190Lm)	1089407
US: 24 x G9 Led 3W 110V (190Lm)	

Certificates:

CE, SASO
UL

Physical characteristics:

1 Box / 135 x 105 x 105 cm / 1,488 m3
 1 Box / 53 1/4 x 41 1/4 x 41 1/4 inches / 90608 in3
 Gross weight 44,1 kg. / Net weight 21,2 kg.

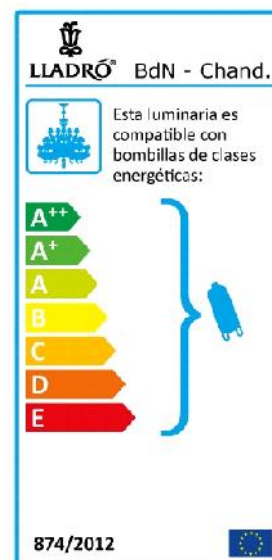

Sketch

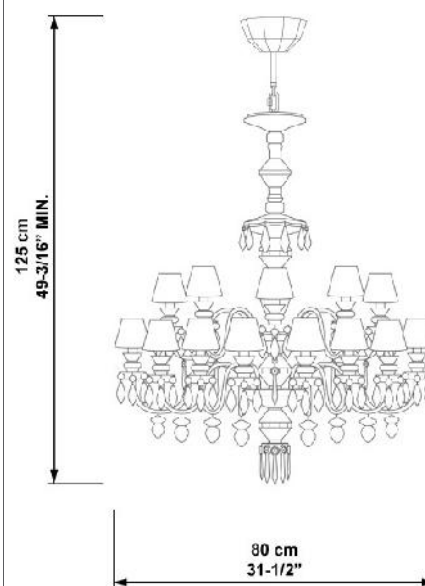

Technical data sheet

CE: Ref 01023237 - UPC/EAN 737859232374
UK: Ref 01023237 - UPC/EAN 737859232374
US: Ref 01023238 - UPC/EAN 737859232374
JP: Ref 01023239 - UPC/EAN 737859232374

Description:

Belle de Nuit - Wall lamp with 2 lights - green
Belle de Nuit - Aplique de pared con 2 luces - verde

Collection:

BELLE DE NUIT

Mounting:

Wall light

Environment:

Wall lamp made of porcelain with decorative back mirror to enhance light effect. Made in different finishes to match all decorative ambiences. Easy to fit for a fast installation. Bespoke measures available under request.

Installation and assembly:

Follow instructions of the installation guide

Electrical characteristics:

Max. Power: 2 x 18W
Tension: CE-UK: 220/240VAC US-JP: 100/125VAC
Frequency: 50/60Hz
 Dimmer not included / LED bulb non dimmable

Recommended Bulb

Bulb not included	Bulb reference
CE: 2 x G9 Led 3W 220V (190Lm)	1089407
US: 2 x G9 Led 3W 110V (190Lm)	

Certificates:

CE, SASO

Physical characteristics:

1 Box / 26,2 x 40,8 x 41,3 cm / 0,044 m3
 1 Box / 10 1/4 x 16 x 16 1/4 inches / 2665 in3
 Gross weight 3,1 kg. / Net weight 1,8 kg.



Sketch

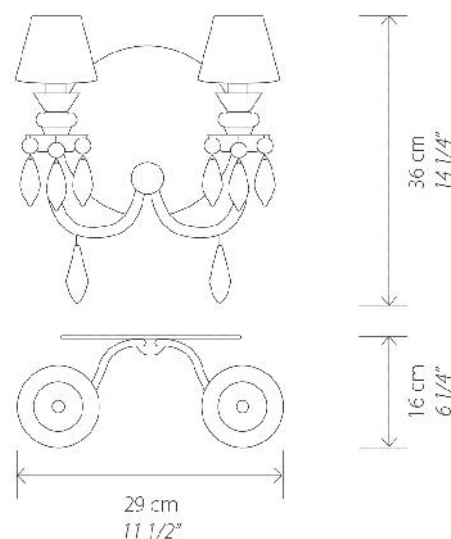

Technical data sheet

CE: Ref 01023240 - UPC/EAN 737859232404
UK: Ref 01023241 - UPC/EAN 737859232404
US: Ref 01023242 - UPC/EAN 737859232404
JP: Ref 01023243 - UPC/EAN 737859232404

Description:

Belle de Nuit - Table Lamp - green
Belle de Nuit - Lámpara de sobremesa - verde

Collection:

BELLE DE NUIT

Mounting:

Table lamp

Environment:

Table lamp body in porcelain. Available in different finishes to match all decorative ambiances

Installation and assembly:

Follow instructions of the installation guide

Electrical characteristics:

Max. Power: 1 x 18W
Tension: CE-UK: 220/240VAC US-JP: 100/125VAC
Frequency: 50/60Hz
 Dimmer not included

Recommended Bulb

Bulb not included	Bulb reference
CE: 1 x E27 LED 6W (600 Lm)	01089432
US: 1 x E26 LED 6W (600 Lm)	

Certificates:

CE, SASO
UL

Physical characteristics:

1 Box / 49,7 x 32,3 x 56,8 cm / 0,091 m3
 1 Box / 19 1/2 x 12 3/4 x 22 1/4 inches / 5532 in3
 Gross weight 3,3 kg. / Net weight 1,3 kg.

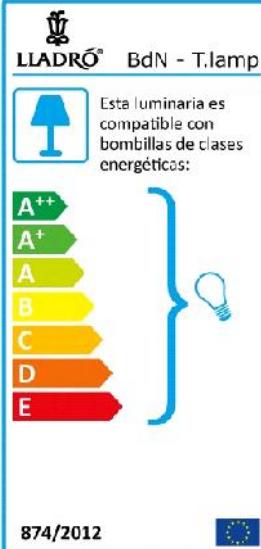
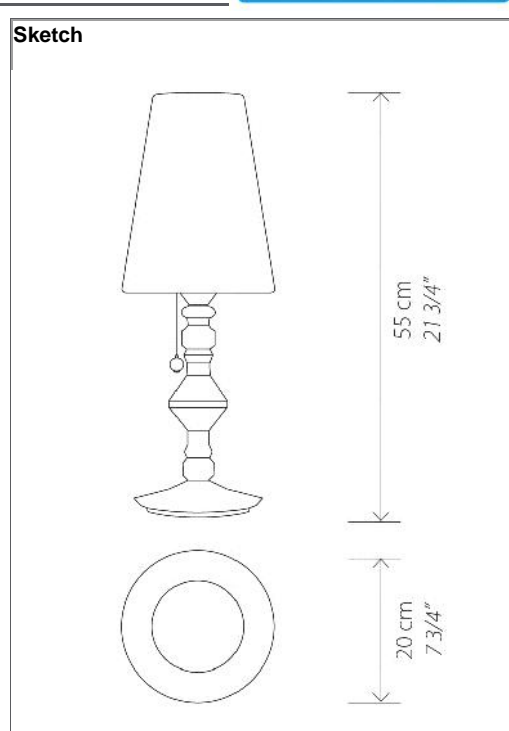
Technical data sheet

CE: Ref 01023244 - UPC/EAN 737859232442
UK: Ref 01023245 - UPC/EAN 737859232442
US: Ref 01023246 - UPC/EAN 737859232442
JP: Ref 01023247 - UPC/EAN 737859232442

Description:

Belle de Nuit - Lithophane Table Lamp - green
Belle de Nuit - Lámpara de sobremesa con Litofanía - verde

Collection:

BELLE DE NUIT

Mounting:

Table lamp

Environment:

Both lamp body and lampshade are made of porcelain. Available in different finishes to match all decorative ambiances.

Installation and assembly:

Follow instructions of the installation guide

Electrical characteristics:

Max. Power: 1 x 18W
Tension: CE-UK: 220/240VAC US-JP: 100/125VAC
Frequency: 50/60Hz
 Dimmer not included / LED bulb non dimmable

Recommended Bulb

	Bulb reference
Bulb not included	
CE: 1 x G9 Led 3W 220V (190Lm)	01089407
US: 1 x Spherical Light bulb LED E12 4W	

Certificates:

CE, SASO
UL

Physical characteristics:

1 Box / 17,9 x 24,9 x 42,3 cm / 0,019 m3
 1 Box / 7 x 9 3/4 x 16 3/4 inches / 1143 in3
 Gross weight 1,4 kg. / Net weight 0,7 kg.



Sketch

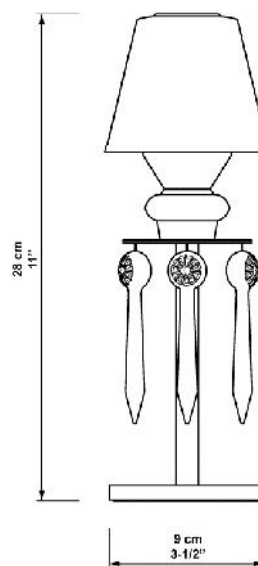

Technical data sheet

CE: Ref 01023248 - UPC/EAN 737859232480
UK: Ref 01023248 - UPC/EAN 737859232480
US: Ref 01023249 - UPC/EAN 737859232480
JP: Ref 01023250 - UPC/EAN 737859232480

Description:

Belle de Nuit -Chandelier 12 lights - blue
Belle de Nuit - Chandelier 12 luces - azul

Collection:

BELLE DE NUIT

Mounting:

Chandelier

Environment:

Chandelier entirely made of porcelain. Made in different finishes to match all decorative ambiences. Not very heavy to simplify its installation. Bespoke measures available under request.

Installation and assembly:

Follow instructions of the installation guide

Electrical characteristics:

Max. Power: 12 x 18W
Tension: CE-UK: 220/240VAC US-JP: 100/125VAC
Frequency: 50/60Hz
 Dimmer not included / LED bulb non dimmable

Recommended Bulb

Bulb not included	Bulb reference
CE: 12 x G9 Led 3W 220V (190Lm)	1089407
US: 12 x G9 Led 3W 110V (190Lm)	

Certificates:

CE, SASO
UL

Physical characteristics:

1 Box / 111 x 82 x 82 cm / 0,746 m3
 1 Box / 43 3/4 x 32 1/4 x 32 1/4 inches / 45503 in3
 Gross weight 36 Kg. / Net weight 8,3 Kg.

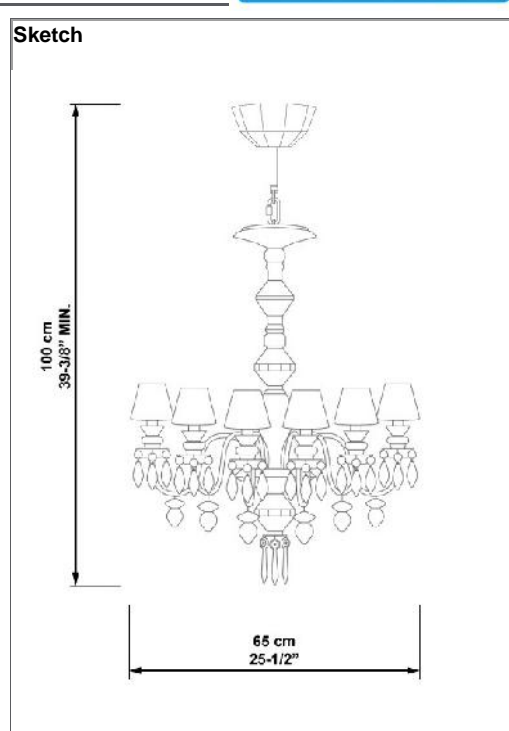
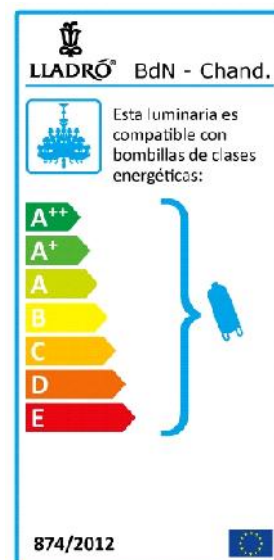

Technical data sheet

CE:	Ref 01023251 - UPC/EAN 737859232510
UK:	Ref 01023251 - UPC/EAN 737859232510
US:	Ref 01023252 - UPC/EAN 737859232510
JP:	Ref 01023253 - UPC/EAN 737859232510

Description:	Belle de Nuit - Chandelier 40 lights - blue Belle de Nuit - Chandelier 40 luces - azul	
Collection:	BELLE DE NUIT	
Mounting:	Chandelier	
Environment:	Chandelier entirely made of porcelain. Made in different finishes to match all decorative ambiances. Not very heavy to simplify its installation. Bespoke measures available under request.	
Installation and assembly:	Follow instructions of the installation guide	
Electrical characteristics:	Max. Power: 40 x 18W Tension: CE-UK: 220/240VAC US-JP: 100/125VAC Frequency: 50/60Hz Dimmer not included / LED bulb non dimmable	
Recommended Bulb	Bulb not included CE: 40 x G9 Led 3W 220V (190Lm) US: 40 x G9 Led 3W 110V (190Lm)	Bulb reference 01089407
Certificates:	CE. SASO UL	
Physical characteristics:	1 Box / 202,67 x 100 x 100 cm / 2,027 m3 1 Box / 79 3/4 x 39 1/4 x 39 1/4 inches / 122860 in3 Gross weight 129,6 kg. / Net weight 27,4 kg.	

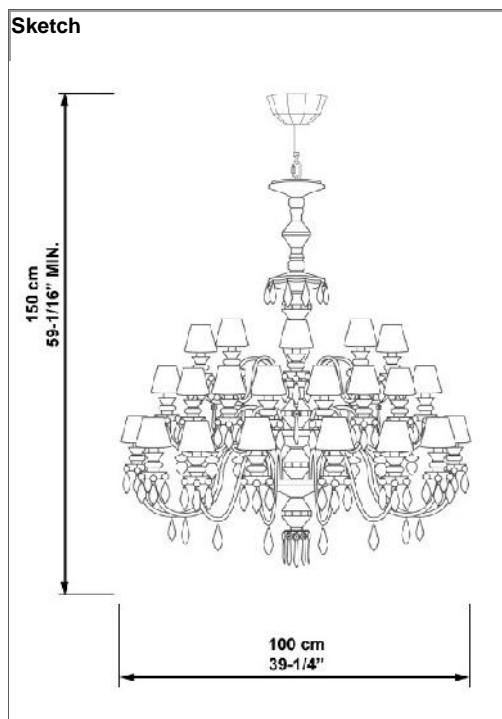

Technical data sheet

CE: Ref 01023254 - UPC/EAN 737859232541
UK: Ref 01023254 - UPC/EAN 737859232541
US: Ref 01023255 - UPC/EAN 737859232541
JP: Ref 01023256 - UPC/EAN 737859232541

Description:

Belle de Nuit -Chandelier 24 lights - blue
Belle de Nuit - Chandelier 24 luces - azul

Collection:

BELLE DE NUIT

Mounting:

Chandelier

Environment:

Chandelier entirely made of porcelain. Made in different finishes to match all decorative ambiences. Not very heavy to simplify its installation. Bespoke measures available under request.

Installation and assembly:

Follow instructions of the installation guide

Electrical characteristics:

Max. Power: 24 x 18W
Tension: CE-UK: 220/240VAC US-JP: 100/125VAC
Frequency: 50/60Hz
 Dimmer not included / LED bulb non dimmable

Recommended Bulb

Bulb not included	Bulb reference
CE: 24 x G9 Led 3W 220V (190Lm)	1089407
US: 24 x G9 Led 3W 110V (190Lm)	

Certificates:

CE, SASO
UL

Physical characteristics:

1 Box / 135 x 105 x 105 cm / 1,488 m3
 1 Box / 53 1/4 x 41 1/4 x 41 1/4 inches / 90608 in3
 Gross weight 44,1 kg. / Net weight 21,2 kg.



Sketch

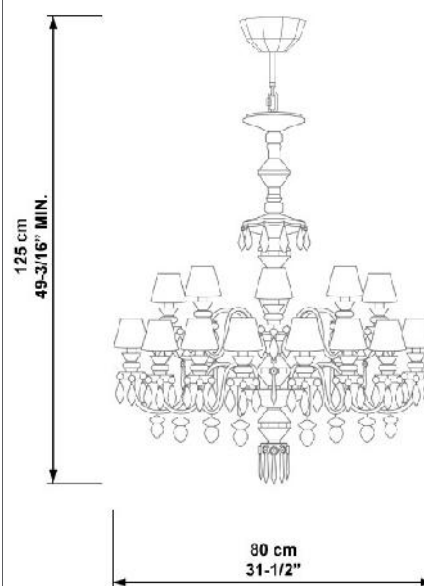

Technical data sheet

CE: Ref 01023257 - UPC/EAN 737859232572
UK: Ref 01023257 - UPC/EAN 737859232572
US: Ref 01023258 - UPC/EAN 737859232572
JP: Ref 01023259 - UPC/EAN 737859232572

Description:

Belle de Nuit - Wall 2 lights - blue
Belle de Nuit - Applique pared 2 luces - azul

Collection:

BELLE DE NUIT

Mounting:

Wall light

Environment:

Wall lamp made of porcelain with decorative back mirror to enhance light effect. Made in different finishes to match all decorative ambiances. Easy to fit for a fast installation. Bespoke measures available under request.

Installation and assembly:

Follow instructions of the installation guide

Electrical characteristics:

Max. Power: 2 x 18W
Tension: CE-UK: 220/240VAC US-JP: 100/125VAC
Frequency: 50/60Hz
 Dimmer not included / LED bulb non dimmable

Recommended Bulb

Bulb not included	Bulb reference
CE: 2 x G9 Led 3W 220V (190Lm)	1089407
US: 2 x G9 Led 3W 110V (190Lm)	

Certificates:

CE, SASO

Physical characteristics:

1 Box / 26,2 x 40,8 x 41,3 cm / 0,044 m3
 1 Box / 10 1/4 x 16 x 16 1/4 inches / 2665 in3
 Gross weight 3,1 kg. / Net weight 1,8 kg.

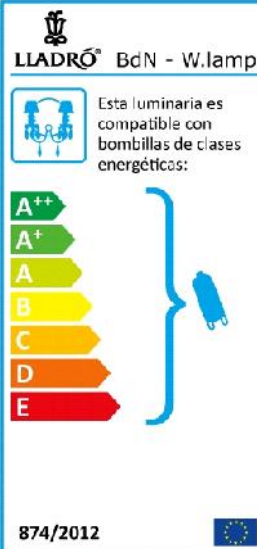

Sketch

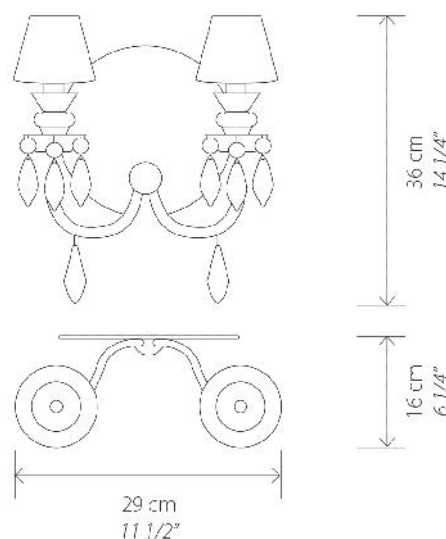

Technical data sheet

CE:	Ref 01023260 - UPC/EAN 737859232602
UK:	Ref 01023261 - UPC/EAN 737859232602
US:	Ref 01023262 - UPC/EAN 737859232602
JP:	Ref 01023263 - UPC/EAN 737859232602

Description: Belle de Nuit - Table Lamp - blue
Belle de Nuit - Lámpara de sobremesa - azul

Collection: BELLE DE NUIT
Mounting: Table lamp

Environment: Table lamp body in porcelain. Available in different finishes to match all decorative ambiances

Installation and assembly: Follow instructions of the installation guide

Electrical characteristics:
Max. Power: 1 x 18W
Tension: CE-UK: 220/240VAC US-JP: 100/125VAC
Frequency: 50/60Hz
 Dimmer not included

Recommended Bulb

Bulb	Bulb reference
CE: 1 x E27 LED 6W (600 Lm)	01089432
US: 1 x E26 LED 6W (600 Lm)	

Certificates: CE, SASO, UL

Physical characteristics:
 1 Box / 49,7 x 32,3 x 56,8 cm / 0,091 m3
 1 Box / 19 1/2 x 12 3/4 x 22 1/4 inches / 5532 in3
 Gross weight 3,3 kg. / Net weight 1,3 kg.

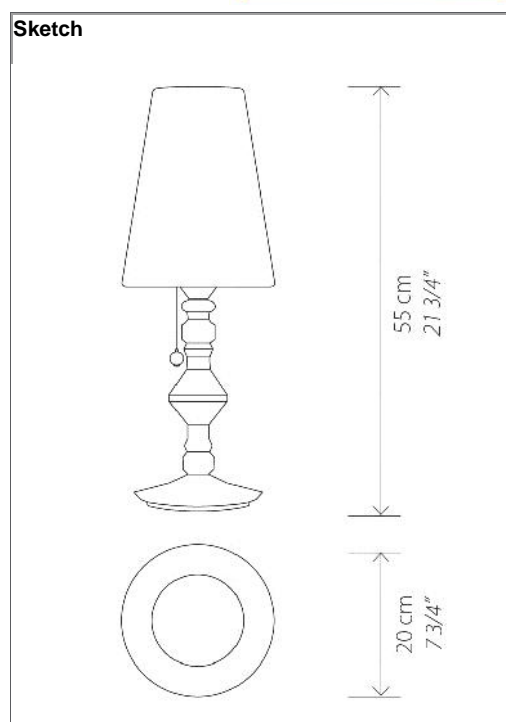
Technical data sheet

CE:	Ref 01023264 - UPC/EAN 737859232640
UK:	Ref 01023265 - UPC/EAN 737859232640
US:	Ref 01023266 - UPC/EAN 737859232640
JP:	Ref 01023267 - UPC/EAN 737859232640

Description:

Belle de Nuit - Lithophane Table Lamp - blue
Belle de Nuit - Lámpara de mesa con Litofanía - azul

Collection:

BELLE DE NUIT

Mounting:

Table lamp

Environment:

Both lamp body and lampshade are made of porcelain. Available in different finishes to match all decorative ambiances.

Installation and assembly:

Follow instructions of the installation guide

Electrical characteristics:

Max. Power: 1 x 18W
Tension: CE-UK: 220/240VAC US-JP: 100/125VAC
Frequency: 50/60Hz
Dimmer not included / LED bulb non dimmable

Recommended Bulb

Bulb not included	Bulb reference
CE: 1 x G9 Led 3W 220V (190Lm)	1089407
US: 1 x E12 Dimmable candle Led 4W	

Certificates:

CE, SASO
UL certification

Physical characteristics:

1 Box / 17,9 x 24,9 x 42,3 cm / 0,019 m3
1 Box / 7 x 9 3/4 x 16 3/4 inches / 1143 in3
Gross weight 1,4 kg. / Net weight 0,7 kg.



Sketch

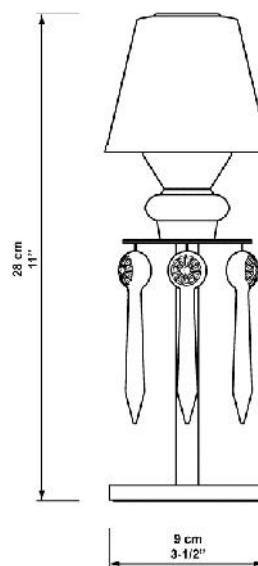

Technical data sheet

CE: Ref 01023268 - UPC/EAN 737859232688
UK: Ref 01023268 - UPC/EAN 737859232688
US: Ref 01023269 - UPC/EAN 737859232688
JP: Ref 01023270 - UPC/EAN 737859232688

Description:

Belle de Nuit - Chandelier 12 lights - pink
Belle de Nuit - Chandelier 12 luces - rosa

Collection:

BELLE DE NUIT

Mounting:

Chandelier

Environment:

Chandelier entirely made of porcelain. Made in different finishes to match all decorative ambiences. Not very heavy to simplify its installation. Bespoke measures available under request.

Installation and assembly:

Follow instructions of the installation guide

Electrical characteristics:

Max. Power: 12 X 18W
Tension: CE-UK: 220/240VAC US-JP: 100/125VAC
Frequency: 50/60Hz
 Dimmer not included / LED bulb non dimmable

Recommended Bulb

Bulb not included	Bulb reference
CE: 12 x G9 Led 3W 220V (190Lm)	01089407
US: 12 x G9 Led 3W 110V (190Lm)	

Certificates:

CE, SASO
UL

Physical characteristics:

1 Box / 111 x 82 x 82 cm / 0,746 m3
 1 Box / 43 3/4 x 32 1/4 x 32 1/4 inches / 45503 in3
 Gross weight 36 Kg. / Net weight 8,3 Kg.

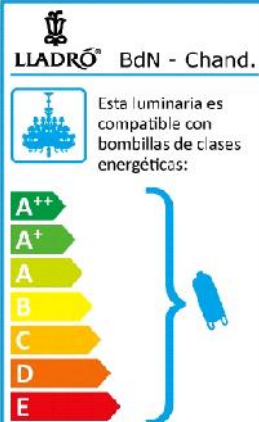

LLADRÓ BdN - Chand.

Esta luminaria es compatible con bombillas de clases energéticas:

A++
A+
A
B
C
D
E

874/2012 

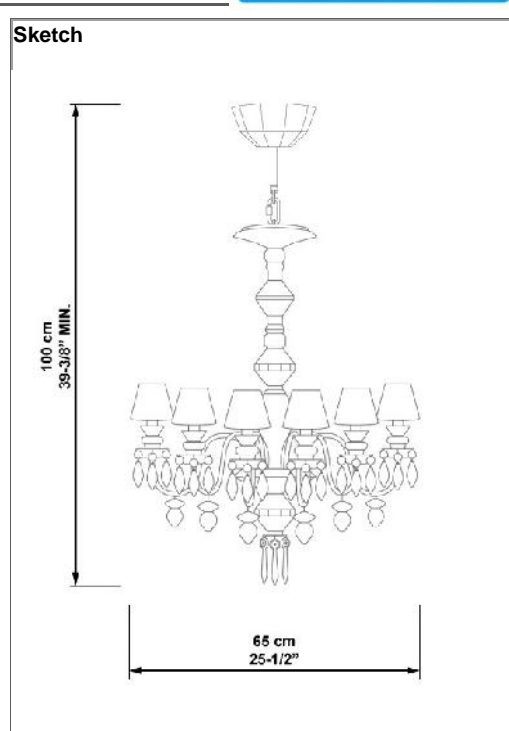

Technical data sheet

CE: Ref 01023271 - UPC/EAN 737859232718
UK: Ref 01023271 - UPC/EAN 737859232718
US: Ref 01023272 - UPC/EAN 737859232718
JP: Ref 01023273 - UPC/EAN 737859232718

Description:

Belle de Nuit - Chandelier 40 lights - pink
Belle de Nuit - Chandelier 40 luces - rosa

Collection:

BELLE DE NUIT

Mounting:

Chandelier

Environment:

Chandelier entirely made of porcelain. Made in different finishes to match all decorative ambiances. Not very heavy to simplify its installation. Bespoke measures available under request.

Installation and assembly:

Follow instructions of the installation guide

Electrical characteristics:

Max. Power: 40 x 18W
Tension: CE-UK: 220/240VAC US-JP: 100/125VAC
Frequency: 50/60Hz
 Dimmer not included / LED bulb non dimmable

Recommended Bulb

Bulb not included	Bulb reference
CE: 40 x G9 Led 3W 220V (190Lm)	01089407
US: 40 x G9 Led 3W 110V (190Lm)	

Certificates:

CE, SASO
UL

Physical characteristics:

1 Box / 140 x 119 x 119 cm / 1,983 m3
 1 Box / 55 x 46 3/4 x 46 3/4 inches / 120206 in3
 Gross weight 129,6 kg. / Net weight 27,4 kg.



Sketch

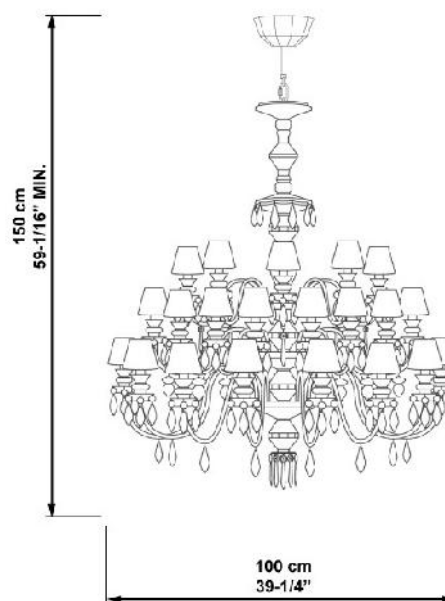

Technical data sheet

CE: Ref 01023274 - UPC/EAN 737859232749
UK: Ref 01023274 - UPC/EAN 737859232749
US: Ref 01023275 - UPC/EAN 737859232749
JP: Ref 01023276 - UPC/EAN 737859232749

Description:

Belle de Nuit - Chandelier 24 lights - pink
Belle de Nuit - Chandelier 24 luces - rosa

Collection:

BELLE DE NUIT

Mounting:

Chandelier

Environment:

Chandelier entirely made of porcelain. Made in different finishes to match all decorative ambiences. Not very heavy to simplify its installation. Bespoke measures available under request.

Installation and assembly:

Follow instructions of the installation guide

Electrical characteristics:

Max. Power: 24 x 18W
Tension: CE-UK: 220/240VAC US-JP: 100/125VAC
Frequency: 50/60Hz
 Dimmer not included / LED bulb non dimmable

Recommended Bulb

Bulb not included	Bulb reference
CE: 24 x G9 Led 3W 220V (190Lm)	01089407
US: 24 x G9 Led 3W 110V (190Lm)	

Certificates:

CE, SASO
UL

Physical characteristics:

1 Box / 135 x 105 x 105 cm / 1,488 m3
 1 Box / 53 1/4 x 41 1/4 x 41 1/4 inches / 90608 in3
 Gross weight 44,1 kg. / Net weight 21,2 kg.



Sketch

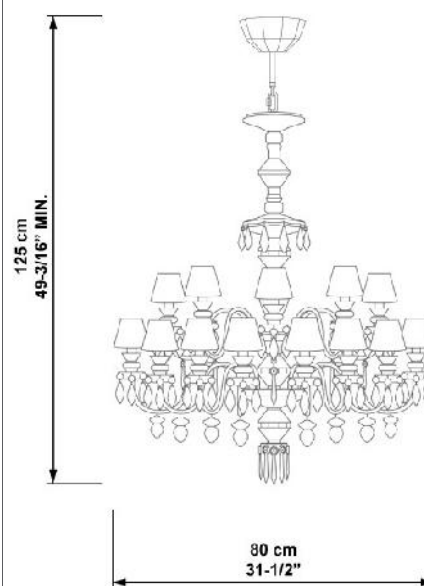

Technical data sheet

CE: Ref 01023277 - UPC/EAN 737859232770
UK: Ref 01023277 - UPC/EAN 737859232770
US: Ref 01023278 - UPC/EAN 737859232770
JP: Ref 01023279 - UPC/EAN 737859232770

Description:

Belle de Nuit - Wall 2 lights - pink
Belle de Nuit - Aplique pared 2 luces - rosa

Collection:

BELLE DE NUIT

Mounting:

Wall light

Environment:

Wall lamp made of porcelain with decorative back mirror to enhance light effect. Made in different finishes to match all decorative ambiances. Easy to fit for a fast installation. Bespoke measures available under request.

Installation and assembly:

Follow instructions of the installation guide

Electrical characteristics:

Max. Power: 40W
Tension: CE-UK: 220/240VAC US-JP: 100/125VAC
Frequency: 50/60Hz
 Dimmer not included / LED bulb non dimmable

Recommended Bulb

Bulb not included **Bulb reference**
CE: 2 x G9 Led 3W 1089407
US:

Certificates:

CE, SASO

Physical characteristics:

1 Box / 26,2 x 40,8 x 41,3 cm / 0,044 m3
 1 Box / 10 1/4 x 16 x 16 1/4 inches / 2665 in3
 Gross weight 3,1 kg. / Net weight 1,8 kg.



LLADRÓ BdN - W.lamp

Esta luminaria es compatible con bombillas de clases energéticas:

A++
A+
A
B
C
D
E

874/2012



Sketch

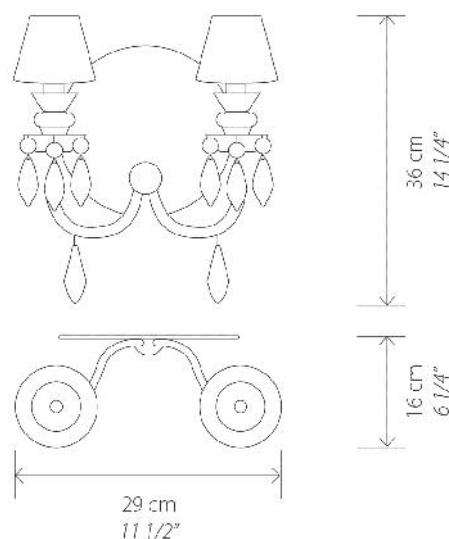

Technical data sheet

CE:	Ref 01023280 - UPC/EAN 737859232800
UK:	Ref 01023281 - UPC/EAN 737859232800
US:	Ref 01023282 - UPC/EAN 737859232800
JP:	Ref 01023283 - UPC/EAN 737859232800

Description:	Belle de Nuit - Table Lamp - pink Belle de Nuit - Lámpara de sobremesa - rosa
Collection:	BELLE DE NUIT
Mounting:	Table lamp
Environment:	Table lamp body in porcelain. Available in different finishes to match all decorative ambiances

Installation and assembly:	Follow instructions of the installation guide	
Electrical characteristics:	Max. Power: 1 x 18W Tension: CE-UK: 220/240VAC US-JP: 100/125VAC Frequency: 50/60Hz Dimmer not included	
Recommended Bulb	Bulb not included CE: 1 x E27 LED 6W (600 Lm) US: 1 x E26 LED 6W (600 Lm)	Bulb reference 01089432
Certificates:	CE, SASO, UL	
Physical characteristics:	1 Box / 49,7 x 32,3 x 56,8 cm / 0,091 m3 1 Box / 19 1/2 x 12 3/4 x 22 1/4 inches / 5532 in3 Gross weight 3,3 kg. / Net weight 1,3 kg.	

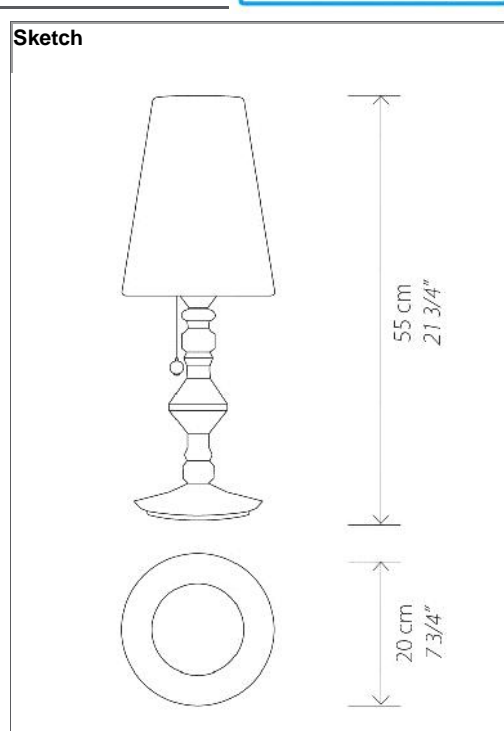
Technical data sheet

CE:	Ref 01023284 - UPC/EAN 737859232848
UK:	Ref 01023285 - UPC/EAN 737859232848
US:	Ref 01023286 - UPC/EAN 737859232848
JP:	Ref 01023287 - UPC/EAN 737859232848

Description:	Belle de Nuit - Lithophane Lamp - pink Belle de Nuit - Lámpara Litofanía - rosa						
Collection:	<i>BELLE DE NUIT</i>						
Mounting:	Table lamp						
Environment:	Both lamp body and lampshade are made of porcelain. Available in different finishes to match all decorative ambiances.						
Installation and assembly:	Follow instructions of the installation guide						
Electrical characteristics:	<p>Max. Power: 1 x 18W</p> <p>Tension: CE-UK: 220/240VAC US-JP: 100/125VAC</p> <p>Frequency: 50/60Hz</p> <p>Dimmer not included / LED bulb non dimmable</p>						
Recommended Bulb	<table border="0"> <thead> <tr> <th>Bulb not included</th> <th>Bulb reference</th> </tr> </thead> <tbody> <tr> <td>CE: 1 x G9 Led 3W 220V (190Lm)</td> <td>1089407</td> </tr> <tr> <td>US: 1 x Edison E12 Incandescent 40W (m</td> <td></td> </tr> </tbody> </table>	Bulb not included	Bulb reference	CE: 1 x G9 Led 3W 220V (190Lm)	1089407	US: 1 x Edison E12 Incandescent 40W (m	
Bulb not included	Bulb reference						
CE: 1 x G9 Led 3W 220V (190Lm)	1089407						
US: 1 x Edison E12 Incandescent 40W (m							
Certificates:	CE, SASO UL						
Physical characteristics:	<p>1 Box / 17,9 x 24,9 x 42,3 cm / 0,019 m³</p> <p>1 Box / 7 x 9 3/4 x 16 3/4 inches / 1143 in³</p> <p>Gross weight 1,4 kg. / Net weight 0,7 kg.</p>						



Sketch

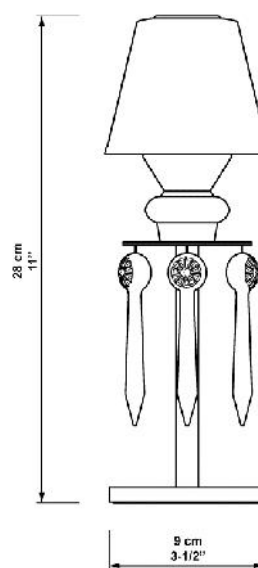

Technical data sheet

CE:	Ref 01023288 - UPC/EAN 737859232886
UK:	Ref 01023288 - UPC/EAN 737859232886
US:	Ref 01023289 - UPC/EAN 737859232886
JP:	Ref 01023290 - UPC/EAN 737859232886

Description:

Belle de Nuit - Chandelier 12 lights - multicolor
Belle de Nuit - Chandelier 12 luces - multicolor

Collection:

BELLE DE NUIT

Mounting:

Chandelier

Environment:

Chandelier entirely made of porcelain. Made in different finishes to match all decorative ambiences. Not very heavy to simplify its installation. Bespoke measures available under request.

Installation and assembly:

Follow instructions of the installation guide

Electrical characteristics:

Max. Power: 12 x 18W
Tension: CE-UK: 220/240VAC US-JP: 100/125VAC
Frequency: 50/60Hz
Dimmer not included / LED bulb non dimmable

Recommended Bulb

Bulb not included	Bulb reference
CE: 12 x G9 Led 3W 220V (190Lm)	01089407
US: 12 x G9 Led 3W 110V (190Lm)	

Certificates:

CE, SASO
UL

Physical characteristics:

1 Box / 111 x 82 x 82 cm / 0,746 m3
1 Box / 43 3/4 x 32 1/4 x 32 1/4 inches / 45503 in3
Gross weight 36 Kg. / Net weight 8,3 Kg.



Sketch

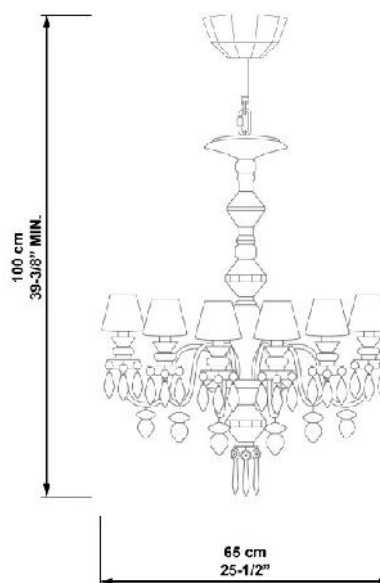

Technical data sheet

CE:	Ref 01023291 - UPC/EAN 737859232916
UK:	Ref 01023291 - UPC/EAN 737859232916
US:	Ref 01023292 - UPC/EAN 737859232916
JP:	Ref 01023293 - UPC/EAN 737859232916

Description:

Belle de Nuit - Chandelier 40 lights - multicolor
Belle de Nuit - Chandelier 40 luces - multicolor

Collection:

BELLE DE NUIT

Mounting:

Chandelier

Environment:

Chandelier entirely made of porcelain. Made in different finishes to match all decorative ambiances. Not very heavy to simplify its installation. Bespoke measures available under request.

Installation and assembly:

Follow instructions of the installation guide

Electrical characteristics:

Max. Power: 40 x 18W
Tension: CE-UK: 220/240VAC US-JP: 100/125VAC
Frequency: 50/60Hz
Dimmer not included / LED bulb non dimmable

Recommended Bulb

Bulb not included	Bulb reference
CE: 40 x G9 Led 3W 220V (190Lm)	01089407
US: 40 x G9 Led 3W 110V (190Lm)	

Certificates:

CE, SASO
UL

Physical characteristics:

1 Box / 140 x 119 x 119 cm / 1,983 m³
1 Box / 55 x 46 3/4 x 46 3/4 inches / 120206 in³
Gross weight 129,6 kg. / Net weight 27,4 kg.



Sketch

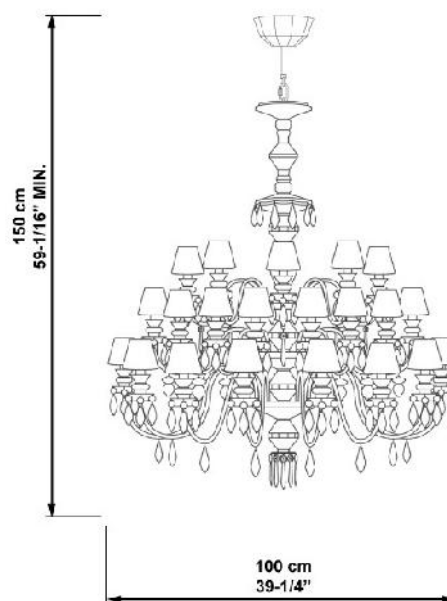

Technical data sheet

CE: Ref 01023294 - UPC/EAN 737859232947
UK: Ref 01023294 - UPC/EAN 737859232947
US: Ref 01023295 - UPC/EAN 737859232947
JP: Ref 01023296 - UPC/EAN 737859232947

Description:

Belle de Nuit - Chandelier 24 lights - multicolor
Belle de Nuit - Chandelier 24 luces - multicolor

Collection:

BELLE DE NUIT

Mounting:

Chandelier

Environment:

Chandelier entirely made of porcelain. Made in different finishes to match all decorative ambiences. Not very heavy to simplify its installation. Bespoke measures available under request.

Installation and assembly:

Follow instructions of the installation guide

Electrical characteristics:

Max. Power: 24 x 18W
Tension: CE-UK: 220/240VAC US-JP: 100/125VAC
Frequency: 50/60Hz
 Dimmer not included / LED bulb non dimmable

Recommended Bulb

Bulb not included	Bulb reference
CE: 24 x G9 Led 3W 220V (190Lm)	01089407
US: 24 x G9 Led 3W 110V (190Lm)	

Certificates:

CE, SASO
UL

Physical characteristics:

1 Box / 135 x 105 x 105 cm / 1,488 m3
 1 Box / 53 1/4 x 41 1/4 x 41 1/4 inches / 90608 in3
 Gross weight 44,1 kg. / Net weight 21,2 kg.

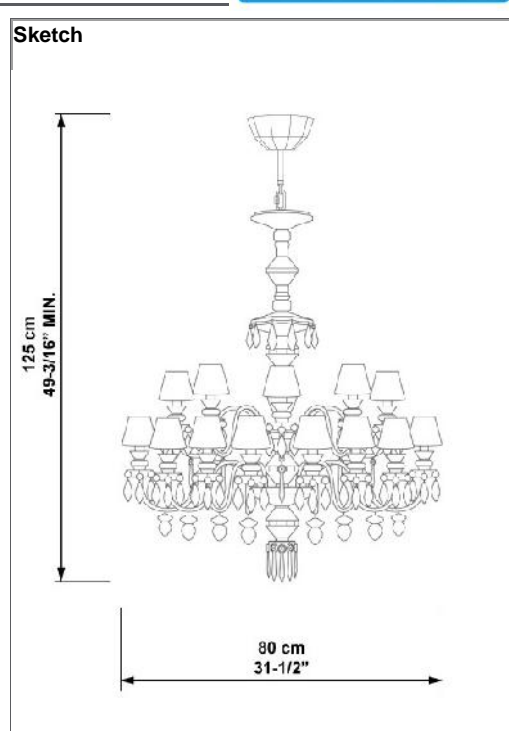
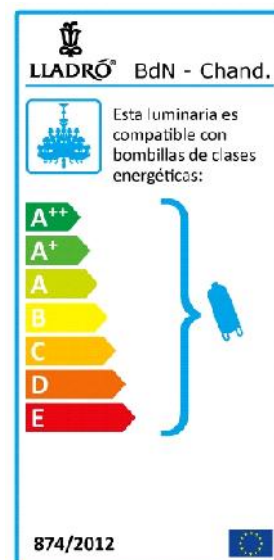

Technical data sheet

CE: Ref 01023297 - UPC/EAN 737859232978
UK: Ref 01023297 - UPC/EAN 737859232978
US: Ref 01023298 - UPC/EAN 737859232978
JP: Ref 01023299 - UPC/EAN 737859232978

Description:

Belle de Nuit - Wall 2 lights - multicolor
Belle de Nuit - Aplique pared 2 luces - multicolor

Collection:

BELLE DE NUIT

Mounting:

Wall light

Environment:

Wall lamp made of porcelain with decorative back mirror to enhance light effect. Made in different finishes to match all decorative ambiances. Easy to fit for a fast installation. Bespoke measures available under request.

Installation and assembly:

Follow instructions of the installation guide

Electrical characteristics:

Max. Power: 2 x 18W
Tension: CE-UK: 220/240VAC US-JP: 100/125VAC
Frequency: 50/60Hz
 Dimmer not included / LED bulb non dimmable

Recommended Bulb

Bulb not included	Bulb reference
CE: 2 x G9 Led 3W 220V (190Lm)	1089407
US: 2 x G9 Led 3W 110V (190Lm)	

Certificates:

CE, SASO

Physical characteristics:

1 Box / 26,2 x 40,8 x 41,3 cm / 0,044 m3
 1 Box / 10 1/4 x 16 x 16 1/4 inches / 2665 in3
 Gross weight 3,1 kg. / Net weight 1,8 kg.



Sketch

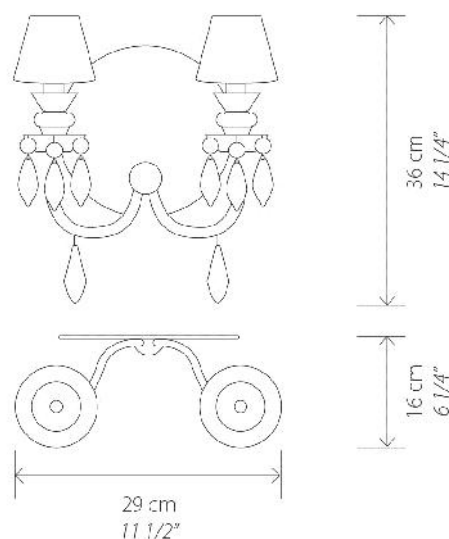

Technical data sheet

CE: Ref 01023300 - UPC/EAN 737859233005
UK: Ref 01023301 - UPC/EAN 737859233005
US: Ref 01023302 - UPC/EAN 737859233005
JP: Ref 01023303 - UPC/EAN 737859233005

Description:

Belle de Nuit - Table Lamp - multicolor
Belle de Nuit - Lámpara de sobremesa - multicolor

Collection:

BELLE DE NUIT

Mounting:

Table lamp

Environment:

Table lamp body in porcelain. Available in different finishes to match all decorative ambiances

Installation and assembly:

Follow instructions of the installation guide

Electrical characteristics:

Max. Power: 1 x 18W
Tension: CE-UK: 220/240VAC US-JP: 100/125VAC
Frequency: 50/60Hz
 Dimmer not included

Recommended Bulb

Bulb not included	Bulb reference
CE: 1 x E27 LED 6W (600 Lm)	01089432
US: 1 x E26 LED 6W (600 Lm)	

Certificates:

CE, SASO
UL

Physical characteristics:

1 Box / 49,7 x 32,3 x 56,8 cm / 0,091 m3
 1 Box / 19 1/2 x 12 3/4 x 22 1/4 inches / 5532 in3
 Gross weight 3,3 kg. / Net weight 1,3 kg.

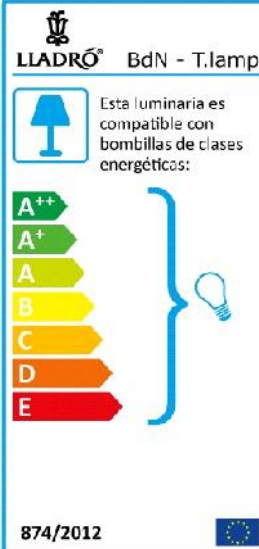
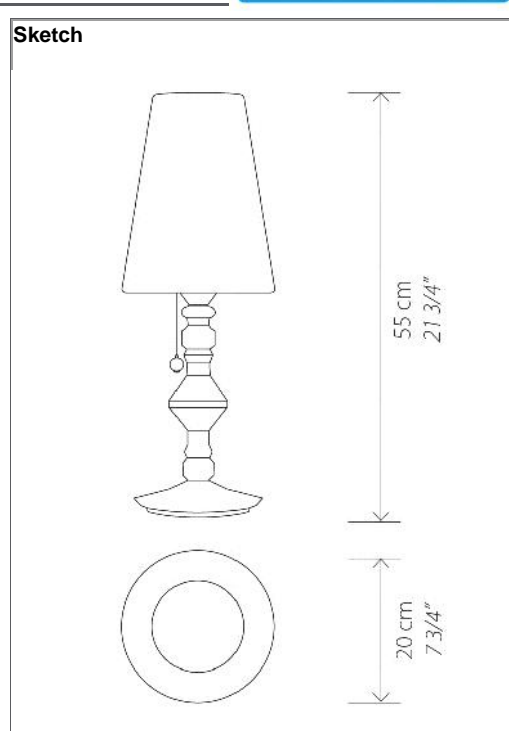
Technical data sheet

CE: Ref 01023308 - UPC/EAN 737859233081
UK: Ref 01023308 - UPC/EAN 737859233081
US: Ref 01023309 - UPC/EAN 737859233081
JP: Ref 01023310 - UPC/EAN 737859233081

Description:

Belle de Nuit - Chandelier 12 lights - gold
Belle de Nuit - Chandelier 12 luces - oro

Collection:

BELLE DE NUIT

Mounting:

Chandelier

Environment:

Chandelier entirely made of porcelain. Made in different finishes to match all decorative ambiences. Not very heavy to simplify its installation. Bespoke measures available under request.

Installation and assembly:

Follow instructions of the installation guide

Electrical characteristics:

Max. Power: 12 x 18W
Tension: CE-UK: 220/240VAC US-JP: 100/125VAC
Frequency: 50/60Hz
 Dimmer not included / LED bulb non dimmable

Recommended Bulb

Bulb not included	Bulb reference
CE: 12 x G9 Led 3W 220V (190Lm)	01089407
US: 12 x G9 Led 3W 110V (190Lm)	

Certificates:

CE, SASO
UL

Physical characteristics:

1 Box / 111 x 82 x 82 cm / 0,746 m3
 1 Box / 43 3/4 x 32 1/4 x 32 1/4 inches / 45503 in3
 Gross weight 36 Kg. / Net weight 8,3 Kg.

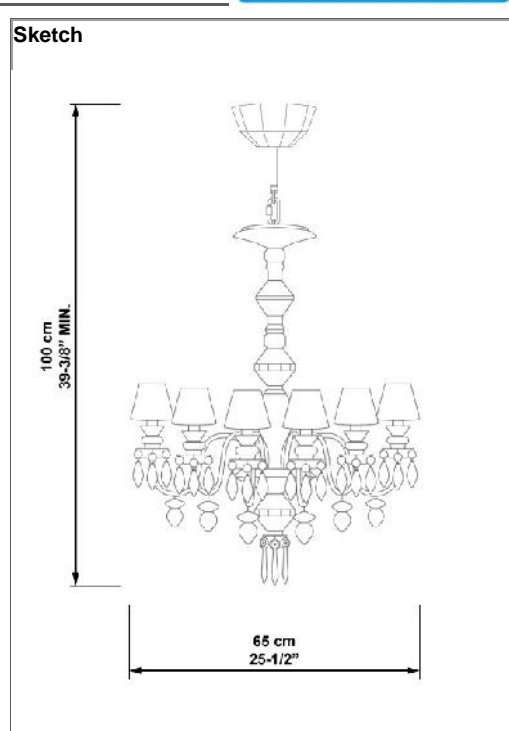
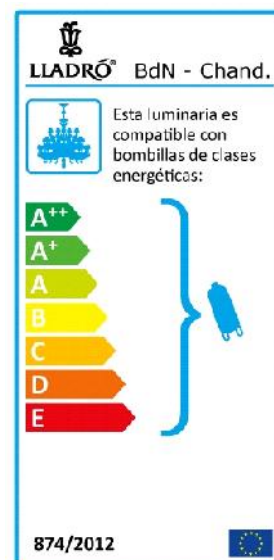

Technical data sheet

CE:	Ref 01023311 - UPC/EAN 737859233111
UK:	Ref 01023311 - UPC/EAN 737859233111
US:	Ref 01023312 - UPC/EAN 737859233111
JP:	Ref 01023313 - UPC/EAN 737859233111

Description:	Belle de Nuit - Chandelier 40 lights - gold Belle de Nuit - Chandelier 40 luces - oro						
Collection:	BELLE DE NUIT						
Mounting:	Chandelier						
Environment:	Chandelier entirely made of porcelain. Made in different finishes to match all decorative ambiances. Not very heavy to simplify its installation. Bespoke measures available under request.						
Installation and assembly:	Follow instructions of the installation guide						
Electrical characteristics:	<p>Max. Power: 40 x 18W</p> <p>Tension: CE-UK: 220/240VAC US-JP: 100/125VAC</p> <p>Frequency: 50/60Hz</p> <p>Dimmer not included / LED bulb non dimmable</p>						
Recommended Bulb	<table border="0"> <tr> <td>Bulb not included</td> <td>Bulb reference</td> </tr> <tr> <td>CE: 40 x G9 Led 3W 220V (190Lm)</td> <td>01089407</td> </tr> <tr> <td>US: 40 x G9 Led 3W 110V (190Lm)</td> <td></td> </tr> </table>	Bulb not included	Bulb reference	CE: 40 x G9 Led 3W 220V (190Lm)	01089407	US: 40 x G9 Led 3W 110V (190Lm)	
Bulb not included	Bulb reference						
CE: 40 x G9 Led 3W 220V (190Lm)	01089407						
US: 40 x G9 Led 3W 110V (190Lm)							
Certificates:	CE. SASO UL						
Physical characteristics:	<p>1 Box / 140 x 119 x 119 cm / 1,983 m³</p> <p>1 Box / 55 x 46 3/4 x 46 3/4 inches / 120206 in³</p> <p>Gross weight 129,6 kg. / Net weight 27,4 kg.</p>						



Sketch

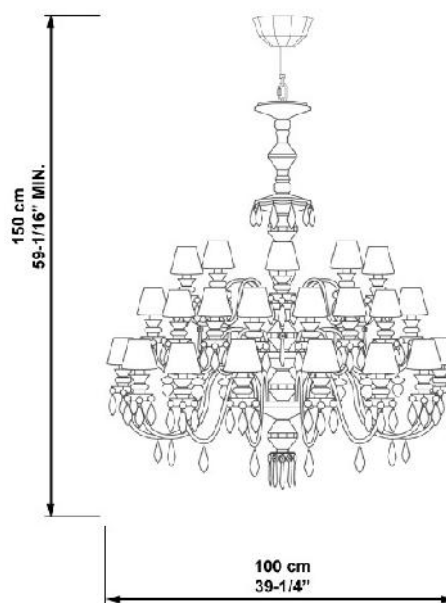

Technical data sheet

CE: Ref 01023314 - UPC/EAN 737859233142
UK: Ref 01023314 - UPC/EAN 737859233142
US: Ref 01023315 - UPC/EAN 737859233142
JP: Ref 01023316 - UPC/EAN 737859233142

Description:

Belle de Nuit - Chandelier 24 lights - gold
Belle de Nuit - Chandelier 24 luces - oro

Collection:

BELLE DE NUIT

Mounting:

Chandelier

Environment:

Chandelier entirely made of porcelain. Made in different finishes to match all decorative ambiances. Not very heavy to simplify its installation. Bespoke measures available under request.

Installation and assembly:

Follow instructions of the installation guide

Electrical characteristics:

Max. Power: 24 x 18W
Tension: CE-UK: 220/240VAC US-JP: 100/125VAC
Frequency: 50/60Hz
 Dimmer not included / LED bulb non dimmable

Recommended Bulb

Bulb not included	Bulb reference
CE: 24 x G9 Led 3W 220V (190Lm)	01089407
US: 24 x G9 Led 3W 110V (190Lm)	

Certificates:

CE, SASO
UL

Physical characteristics:

1 Box / 135 x 105 x 105 cm / 1,488 m3
 1 Box / 53 1/4 x 41 1/4 x 41 1/4 inches / 90608 in3
 Gross weight 44,1 kg. / Net weight 21,2 kg.



LLADRÓ BdN - Chand.

Esta luminaria es compatible con bombillas de clases energéticas:

A++
A+
A
B
C
D
E

874/2012 

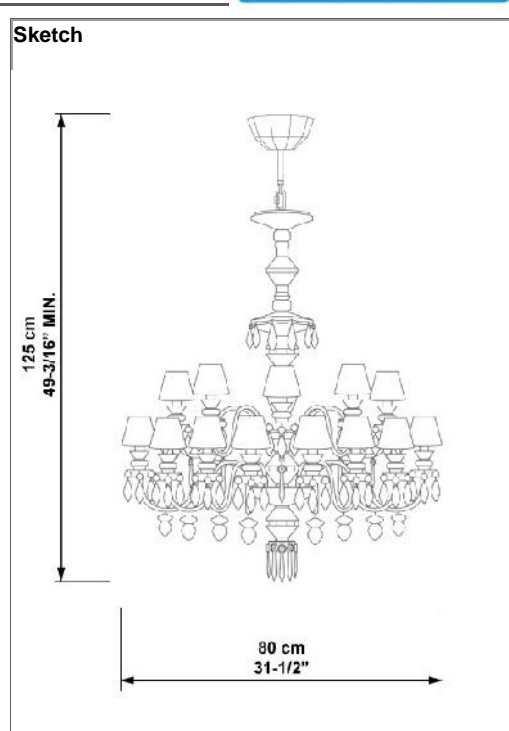

Technical data sheet

CE: Ref 01023317 - UPC/EAN 737859233173
UK: Ref 01023317 - UPC/EAN 737859233173
US: Ref 01023318 - UPC/EAN 737859233173
JP: Ref 01023319 - UPC/EAN 737859233173

Description:

Belle de Nuit - Wall 2 lights - gold
Belle de Nuit - Applique pared 2 luces - oro

Collection:

BELLE DE NUIT

Mounting:

Wall light

Environment:

Wall lamp made of porcelain with decorative back mirror to enhance light effect. Made in different finishes to match all decorative ambiances. Easy to fit for a fast installation. Bespoke measures available under request.

Installation and assembly:

Follow instructions of the installation guide

Electrical characteristics:

Max. Power: 2 x 18W
Tension: CE-UK: 220/240VAC US-JP: 100/125VAC
Frequency: 50/60Hz
 Dimmer not included / LED bulb non dimmable

Recommended Bulb

Bulb not included	Bulb reference
CE: 2 x G9 Led 3W 220V (190Lm)	1089407
US: 2 x G9 Led 3W 110V (190Lm)	

Certificates:

CE, SASO

Physical characteristics:

1 Box / 26,2 x 40,8 x 41,3 cm / 0,044 m3
 1 Box / 10 1/4 x 16 x 16 1/4 inches / 2665 in3
 Gross weight 3,1 kg. / Net weight 1,8 kg.



Sketch

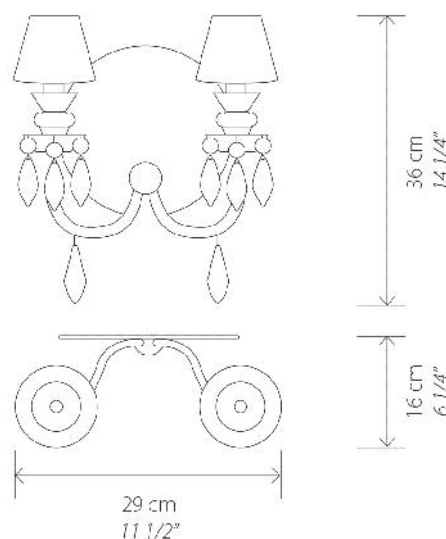

Technical data sheet

CE: Ref 01023320 - UPC/EAN 737859233203
UK: Ref 01023321 - UPC/EAN 737859233203
US: Ref 01023322 - UPC/EAN 737859233203
JP: Ref 01023323 - UPC/EAN 737859233203

Description:

Belle de Nuit - Table Lamp - gold
Belle de Nuit - Lámpara de sobremesa - oro

Collection:

BELLE DE NUIT

Mounting:

Table lamp

Environment:

Table lamp body in porcelain. Available in different finishes to match all decorative ambiances

Installation and assembly:

Follow instructions of the installation guide

Electrical characteristics:

Max. Power: 1 x 18W
Tension: CE-UK: 220/240VAC US-JP: 100/125VAC
Frequency: 50/60Hz
 Dimmer not included

Recommended Bulb

Bulb not included	Bulb reference
CE: 1 x E27 LED 6W (600 Lm)	01089432
US: 1 x E26 LED 6W (600 Lm)	

Certificates:

CE, SASO
UL

Physical characteristics:

1 Box / 49,7 x 32,3 x 56,8 cm / 0,091 m3
 1 Box / 19 1/2 x 12 3/4 x 22 1/4 inches / 5532 in3
 Gross weight 3,3 kg. / Net weight 1,3 kg.

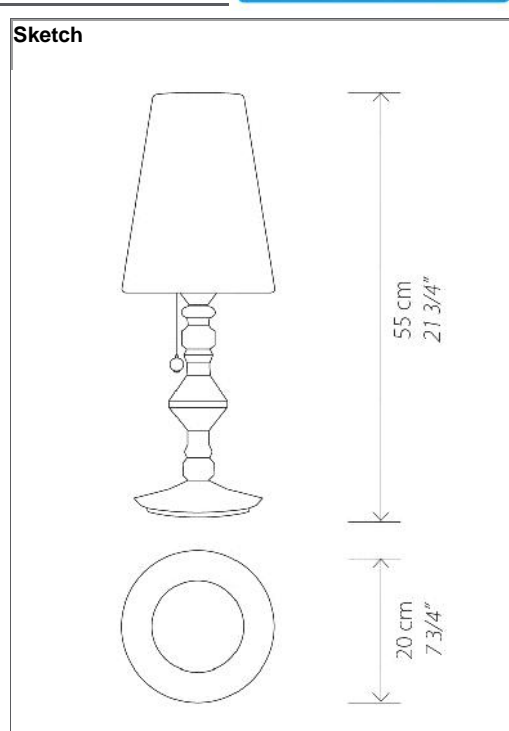
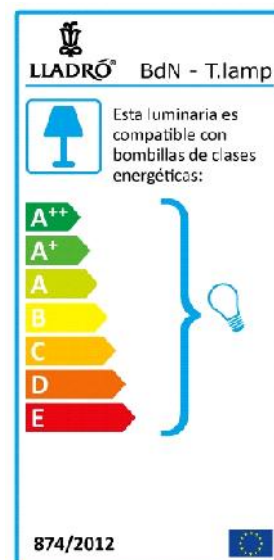

Technical data sheet

CE:	Ref 01023324 - UPC/EAN 737859233241
UK:	Ref 01023325 - UPC/EAN 737859233241
US:	Ref 01023326 - UPC/EAN 737859233241
JP:	Ref 01023327 - UPC/EAN 737859233241

Description:	Belle de Nuit - Lithophane Table Lamp - gold Belle de Nuit - Lámpara de mesa con Litofanía - oro						
Collection:	<i>BELLE DE NUIT</i>						
Mounting:	Table lamp						
Environment:	Both lamp body and lampshade are made of porcelain. Available in different finishes to match all decorative ambiances.						
Installation and assembly:	Follow instructions of the installation guide						
Electrical characteristics:	<p>Max. Power: 1 x 18W</p> <p>Tension: CE-UK: 220/240VAC US-JP: 100/125VAC</p> <p>Frequency: 50/60Hz</p> <p>Dimmer not included / LED bulb non dimmable</p>						
Recommended Bulb	<table border="0"> <thead> <tr> <th>Bulb not included</th> <th>Bulb reference</th> </tr> </thead> <tbody> <tr> <td>CE: 1 x G9 Led 3W (máx: 20W)</td> <td>1089407</td> </tr> <tr> <td>US: 1 x Edison E12 Incandescent 40W (m</td> <td></td> </tr> </tbody> </table>	Bulb not included	Bulb reference	CE: 1 x G9 Led 3W (máx: 20W)	1089407	US: 1 x Edison E12 Incandescent 40W (m	
Bulb not included	Bulb reference						
CE: 1 x G9 Led 3W (máx: 20W)	1089407						
US: 1 x Edison E12 Incandescent 40W (m							
Certificates:	CE. SASO UL certification						
Physical characteristics:	<p>1 Box / 17,9 x 24,9 x 42,3 cm / 0,019 m3</p> <p>1 Box / 7 x 9 3/4 x 16 3/4 inches / 1143 in3</p> <p>Gross weight 1,4 kg. / Net weight 0,7 kg.</p>						



Sketch

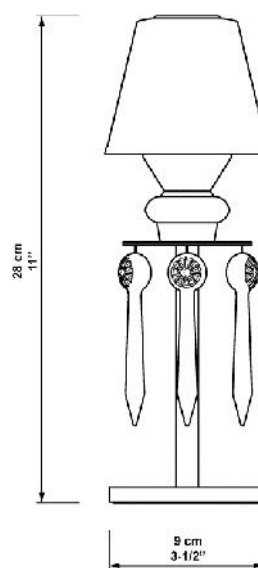

Technical data sheet

CE: Ref 01023363 - UPC/EAN 737859233630
UK: Ref 01023363 - UPC/EAN 737859233630
US: Ref 01023364 - UPC/EAN 737859233630
JP: Ref 01023365 - UPC/EAN 737859233630

Description:

Belle de Nuit - pendant lamp I - white
Belle de Nuit - Lámpara de techo I - blanco

Collection:

BELLE DE NUIT

Mounting:

Pendant

Environment:

Hanging lamp body made of porcelain. Available in different finishes to match all decorative ambiances. Easy to fix to ceiling system and capable of changing length during installation. This model fits well on a corner display but also on reception desks.

Installation and assembly:

Follow instructions of the installation guide

Electrical characteristics:

Max. Power: 1 x 18W
Tension: CE-UK: 220/240VAC US-JP: 100/125VAC
Frequency: 50/60Hz
 Dimmer not included

Recommended Bulb

Bulb not included	Bulb reference
CE: 1 x E27 LED 6W (600 Lm)	01089432
US: 1 x E26 LED 6W (600 Lm)	

Certificates:

CE, SASO
UL

Physical characteristics:

1 Box / 9,153 x 100 x 100 cm / 0,092 m3
 1 Box / 3 1/2 x 39 1/4 x 39 1/4 inches / 5392 in3
 Gross weight 3,3 Kg. / Net weight 1,2 Kg.

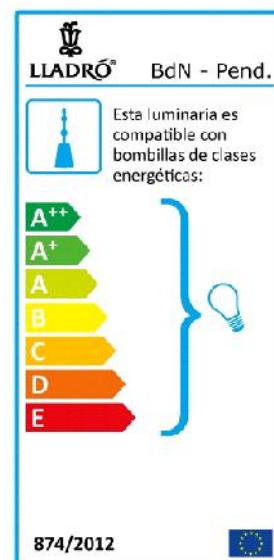

Sketch

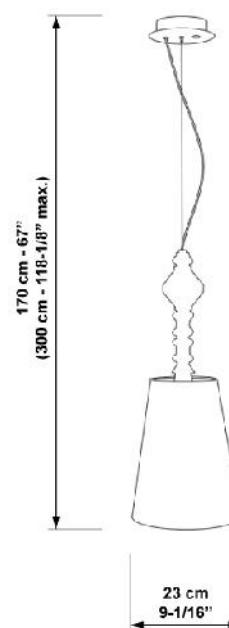

Technical data sheet

CE: Ref 01023366 - UPC/EAN 737859233661
UK: Ref 01023366 - UPC/EAN 737859233661
US: Ref 01023367 - UPC/EAN 737859233661
JP: Ref 01023368 - UPC/EAN 737859233661

Description:

Belle de Nuit - pendant lamp II - white
Belle de Nuit - Lámpara de techo II - blanco

Collection:

BELLE DE NUIT

Mounting:

Pendant

Environment:

Hanging lamp body made of porcelain. Available in different finishes to match all decorative ambiances. Easy to fix to ceiling system and capable of changing length during installation. This model fits well on a corner display but also on reception desks.

Installation and assembly:

Follow instructions of the installation guide

Electrical characteristics:

Max. Power: 1 x 18W
Tension: CE-UK: 220/240VAC US-JP: 100/125VAC
Frequency: 50/60Hz
 Dimmer not included

Recommended Bulb

Bulb not included	Bulb reference
CE: 1 x E27 LED 6W (600 Lm)	01089432
US: 1 x E26 LED 6W (600 Lm)	

Certificates:

CE, SASO
 UL

Physical characteristics:

1 Box / 10,694 x 100 x 100 cm / 0,107 m3
 1 Box / 4 1/4 x 39 1/4 x 39 1/4 inches / 6547 in3
 Gross weight 4,1 Kg. / Net weight 1,8 Kg.

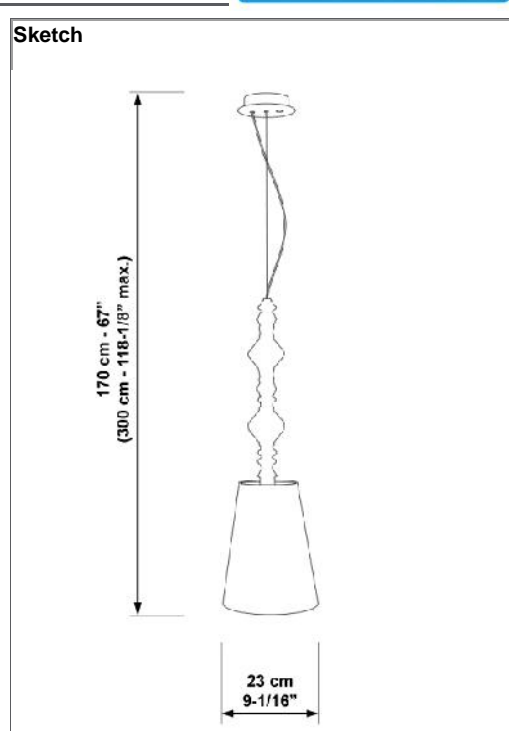
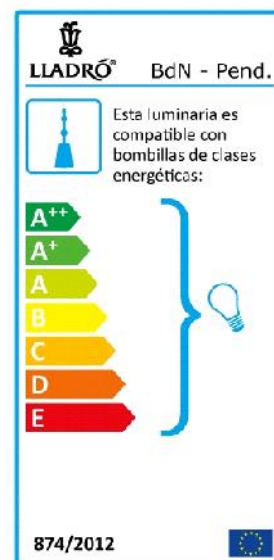

Technical data sheet

CE: Ref 01023369 - UPC/EAN 737859233692
UK: Ref 01023370 - UPC/EAN 737859233692
US: Ref 01023371 - UPC/EAN 737859233692
JP: Ref 01023372 - UPC/EAN 737859233692

Description:

Belle de Nuit - Floor Lamp I - white
Belle de Nuit - Lámpara de pie I - blanco

Collection:

BELLE DE NUIT

Mounting:

Floor lamp

Environment:

Standing lamp body made of porcelain. Available in different finishes to match all decorative ambiances. This model fits well alone or in combination with other items from the same collection

Installation and assembly:

Follow instructions of the installation guide

Electrical characteristics:

Max. Power: 1 x 18W
Tension: CE-UK: 220/240VAC US-JP: 100/125VAC
Frequency: 50/60Hz

Recommended Bulb

Bulb not included **Bulb reference**
CE: 1 x E27 LED 6W (600 Lm)
US: 1 x E26 LED 6W (600 Lm)

Certificates:

CE, SASO
 UL

Physical characteristics:

1 Box / 35 x 33 x 193 cm / 0,223 m3
 1 Box / 13 3/4 x 13 x 76 inches / 13585 in3
 Gross weight 7,7 Kg. / Net weight 3,9 Kg.



Sketch

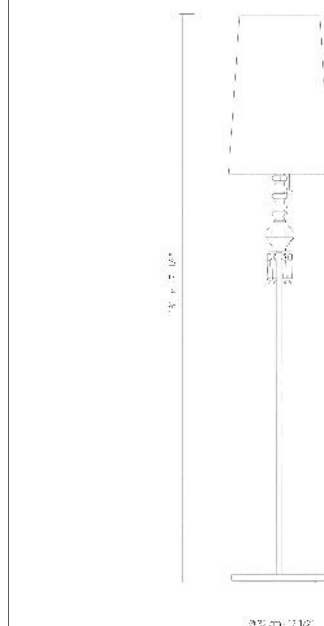

Technical data sheet

CE: Ref 01023373 - UPC/EAN 737859233739
UK: Ref 01023374 - UPC/EAN 737859233739
US: Ref 01023375 - UPC/EAN 737859233739
JP: Ref 01023376 - UPC/EAN 737859233739

Description:

Belle de Nuit - Floor Lamp II - white
Belle de Nuit - Lámpara de pie II - blanco

Collection:

BELLE DE NUIT

Mounting:

Floor lamp

Environment:

Standing lamp body made of porcelain. Available in different finishes to match all decorative ambiances. This model fits well alone or in combination with other items from the same collection

Installation and assembly:

Follow instructions of the installation guide

Electrical characteristics:

Max. Power: 1 x 18W
Tension: CE-UK: 220/240VAC US-JP: 100/125VAC
Frequency: 50/60Hz

Recommended Bulb

Bulb not included **Bulb reference**
CE: 1 x E27 LED 6W (600 Lm)
US: 1 x E26 LED 6W (600 Lm)

Certificates:

CE, SASO
 UL

Physical characteristics:

1 Box / 35 x 33 x 193 cm / 0,223 m3
 1 Box / 13 3/4 x 13 x 76 inches / 13585 in3
 Gross weight 8,6 Kg. / Net weight 4,2 Kg.



Sketch

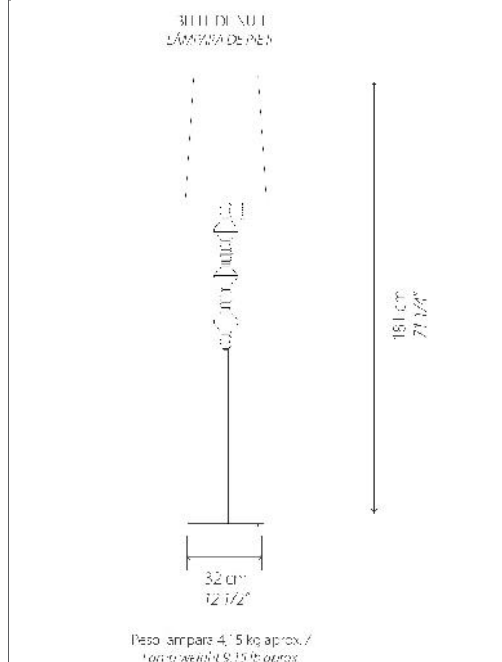

Technical data sheet

CE: Ref 01023380 - UPC/EAN 737859233807
UK: Ref 01023380 - UPC/EAN 737859233807
US: Ref 01023381 - UPC/EAN 737859233807
JP: Ref 01023382 - UPC/EAN 737859233807

Description:

Belle de Nuit - pendant lamp I - black
Belle de Nuit - Lámpara de techo I - negro

Collection:

BELLE DE NUIT

Mounting:

Pendant

Environment:

Hanging lamp body made of porcelain. Available in different finishes to match all decorative ambiances. Easy to fix to ceiling system and capable of changing length during installation. This model fits well on a corner display but also on reception desks.

Installation and assembly:

Follow instructions of the installation guide

Electrical characteristics:

Max. Power: 1 x 18W
Tension: CE-UK: 220/240VAC US-JP: 100/125VAC
Frequency: 50/60Hz
 Dimmer not included

Recommended Bulb

Bulb not included	Bulb reference
CE: 1 x E27 LED 6W (600 Lm)	01089432
US: 1 x E26 LED 6W (600 Lm)	

Certificates:

CE, SASO
UL

Physical characteristics:

1 Box / 9,153 x 100 x 100 cm / 0,092 m3
 1 Box / 3 1/2 x 39 1/4 x 39 1/4 inches / 5392 in3
 Gross weight 3,3 Kg. / Net weight 1,2 Kg.

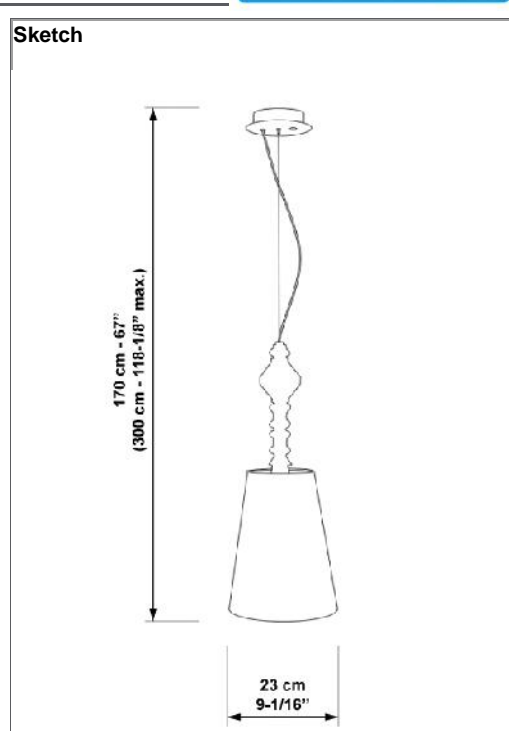
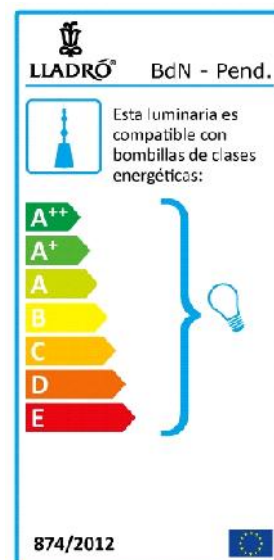

Technical data sheet

CE:	Ref 01023383 - UPC/EAN 737859233838
UK:	Ref 01023383 - UPC/EAN 737859233838
US:	Ref 01023384 - UPC/EAN 737859233838
JP:	Ref 01023385 - UPC/EAN 737859233838

Description:

Belle de Nuit - pendant lamp II - black
Belle de Nuit - Lámpara de techo II - negro

Collection:

BELLE DE NUIT

Mounting:

Pendant

Environment:

Hanging lamp body made of porcelain. Available in different finishes to match all decorative ambiances. Easy to fix to ceiling system and capable of changing length during installation. This model fits well on a corner display but also on reception desks.

Installation and assembly:

Follow instructions of the installation guide

Electrical characteristics:

Max. Power: 1 x 18W
Tension: CE-UK: 220/240VAC US-JP: 100/125VAC
Frequency: 50/60Hz
Dimmer not included

Recommended Bulb

Bulb not included	Bulb reference
CE: 1 x E27 LED 6W (600 Lm)	01089432
US: 1 x E26 LED 6W (600 Lm)	

Certificates:

CE, SASO, CCC
UL

Physical characteristics:

1 Box / 10,694 x 100 x 100 cm / 0,107 m3
1 Box / 4 1/4 x 39 1/4 x 39 1/4 inches / 6547 in3
Gross weight 4,1 Kg. / Net weight 1,8 Kg.

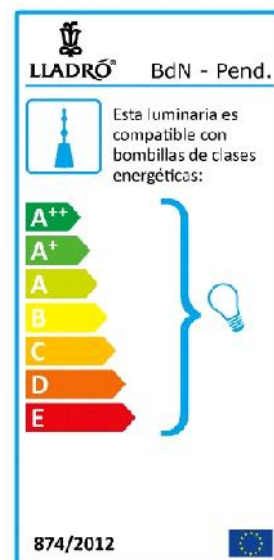

Sketch

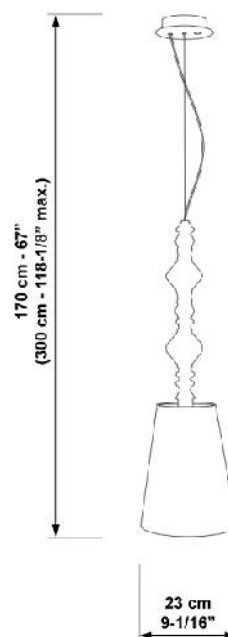

Technical data sheet

CE: Ref 01023386 - UPC/EAN 737859233869
UK: Ref 01023387 - UPC/EAN 737859233869
US: Ref 01023388 - UPC/EAN 737859233869
JP: Ref 01023389 - UPC/EAN 737859233869

Description:

Belle de Nuit - Floor Lamp I - black
Belle de Nuit - Lámpara de pie I - negro

Collection:

BELLE DE NUIT

Mounting:

Floor lamp

Environment:

Standing lamp body made of porcelain. Available in different finishes to match all decorative ambiances. This model fits well alone or in combination with other items from the same collection

Installation and assembly:

Follow instructions of the installation guide

Electrical characteristics:

Max. Power: 1 x 18W
Tension: CE-UK: 220/240VAC US-JP: 100/125VAC
Frequency: 50/60Hz

Recommended Bulb

Bulb not included **Bulb reference**
CE: 1 x E27 LED 6W (600 Lm)
US: 1 x E26 LED 6W (600 Lm)

Certificates:

CE, SASO
 UL

Physical characteristics:

1 Box / 35 x 33 x 193 cm / 0,223 m3
 1 Box / 13 3/4 x 13 x 76 inches / 13585 in3
 Gross weight 7,7 Kg. / Net weight 3,9 Kg.



Sketch

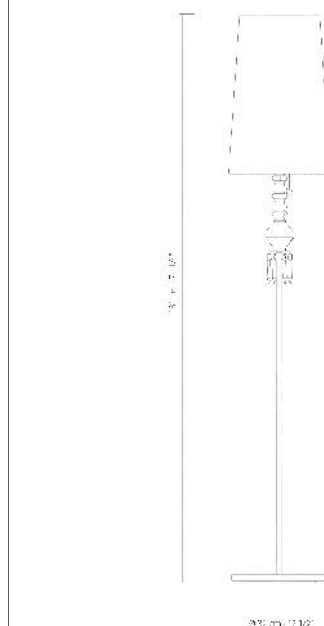

Technical data sheet

CE:	Ref 01023390 - UPC/EAN 737859233906
UK:	Ref 01023391 - UPC/EAN 737859233906
US:	Ref 01023392 - UPC/EAN 737859233906
JP:	Ref 01023393 - UPC/EAN 737859233906

Description:

Belle de Nuit - Floor Lamp II - black
Belle de Nuit - Lámpara de pie II - negro

Collection:

BELLE DE NUIT

Mounting:

Floor lamp

Environment:

Standing lamp body made of porcelain. Available in different finishes to match all decorative ambiances. This model fits well alone or in combination with other items from the same collection

Installation and assembly:

Follow instructions of the installation guide

Electrical characteristics:

Max. Power: 1 x 18W
Tension: CE-UK: 220/240VAC US-JP: 100/125VAC
Frequency: 50/60Hz

Recommended Bulb

Bulb not included **Bulb reference**
CE: 1 x E27 LED 6W (600 Lm)
US: 1 x E26 LED 6W (600 Lm)

Certificates:

CE, SASO
UL

Physical characteristics:

1 Box / 35 x 33 x 193 cm / 0,223 m3
1 Box / 13 3/4 x 13 x 76 inches / 13585 in3
Gross weight 8,6 Kg. / Net weight 4,2 Kg.



Sketch

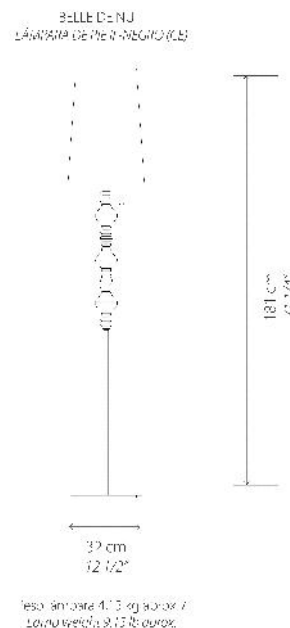

Technical data sheet

CE: Ref 01023394 - UPC/EAN 737859233944
UK: Ref 01023394 - UPC/EAN 737859233944
US: Ref 01023395 - UPC/EAN 737859233944
JP: Ref 01023396 - UPC/EAN 737859233944

Description:

Belle de Nuit - lithophane hanging lamp - black
Belle de Nuit - Lámpara litofanía colgante - negro

Collection:

BELLE DE NUIT

Mounting:

Pendant

Environment:

Both hanging lamp body and lampshade are made of porcelain. Available in different finishes to match all decorative ambiances. Easy to fix to ceiling system and capable of changing length during installation. This model fits well on a corner display

Installation and assembly:

Follow instructions of the installation guide

Electrical characteristics:

Max. Power: 1 x 18W
Tension: CE-UK: 220/240VAC US-JP: 100/125VAC
Frequency: 50/60Hz

Recommended Bulb

Bulb not included	Bulb reference
CE: 1 x G9 LED 3W 220V (190Lm)	01089407
US: 1 x G9 LED 3W 110V (190Lm)	

Certificates:

CE, SASO

Physical characteristics:

1 Box / 17,9 x 24,9 x 42,3 cm / 0,019 m3
 1 Box / 7 x 9 3/4 x 16 3/4 inches / 1143 in3
 Gross weight 1,7 Kg. / Net weight 0,8 Kg.



Sketch

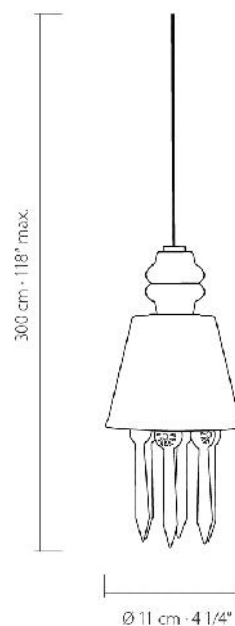

Technical data sheet

CE: Ref 01023397 - UPC/EAN 737859233975
UK: Ref 01023397 - UPC/EAN 737859233975
US: Ref 01023398 - UPC/EAN 737859233975
JP: Ref 01023399 - UPC/EAN 737859233975

Description:

Belle de Nuit - pendant lamp I - blue
Belle de Nuit - Lámpara de techo I - azul

Collection:

BELLE DE NUIT

Mounting:

Pendant

Environment:

Hanging lamp body made of porcelain. Available in different finishes to match all decorative ambiances. Easy to fix to ceiling system and capable of changing length during installation. This model fits well on a corner display but also on reception desks.

Installation and assembly:

Follow instructions of the installation guide

Electrical characteristics:

Max. Power: 1 x 18W
Tension: CE-UK: 220/240VAC US-JP: 100/125VAC
Frequency: 50/60Hz
 Dimmer not included

Recommended Bulb

Bulb not included	Bulb reference
CE: 1 x E27 LED 6W (600 Lm)	01089432
US: 1 x E26 LED 6W (600 Lm)	

Certificates:

CE, SASO
UL

Physical characteristics:

1 Box / 9,153 x 100 x 100 cm / 0,092 m3
 1 Box / 3 1/2 x 39 1/4 x 39 1/4 inches / 5392 in3
 Gross weight 3,3 Kg. / Net weight 1,2 Kg.

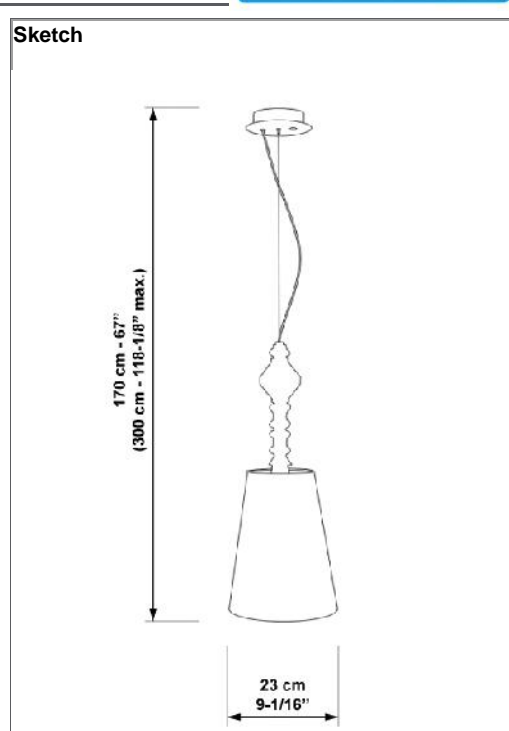
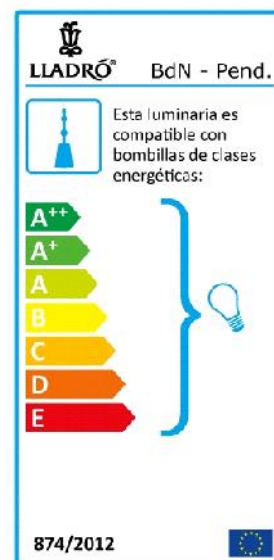

Technical data sheet

CE: Ref 01023400 - UPC/EAN 737859234002
UK: Ref 01023400 - UPC/EAN 737859234002
US: Ref 01023401 - UPC/EAN 737859234002
JP: Ref 01023402 - UPC/EAN 737859234002

Description:

Belle de Nuit - pendant lamp II - blue
Belle de Nuit - Lámpara de techo II - azul

Collection:

BELLE DE NUIT

Mounting:

Pendant

Environment:

Hanging lamp body made of porcelain. Available in different finishes to match all decorative ambiances. Easy to fix to ceiling system and capable of changing length during installation. This model fits well on a corner display but also on reception desks.

Installation and assembly:

Follow instructions of the installation guide

Electrical characteristics:

Max. Power: 1 x 18W
Tension: CE-UK: 220/240VAC US-JP: 100/125VAC
Frequency: 50/60Hz
 Dimmer not included

Recommended Bulb

Bulb not included	Bulb reference
CE: 1 x E27 LED 6W (600 Lm)	01089432
US: 1 x E26 LED 6W (600 Lm)	

Certificates:

CE, SASO
UL

Physical characteristics:

1 Box / 10,694 x 100 x 100 cm / 0,107 m3
 1 Box / 4 1/4 x 39 1/4 x 39 1/4 inches / 6547 in3
 Gross weight 4,1 Kg. / Net weight 1,8 Kg.

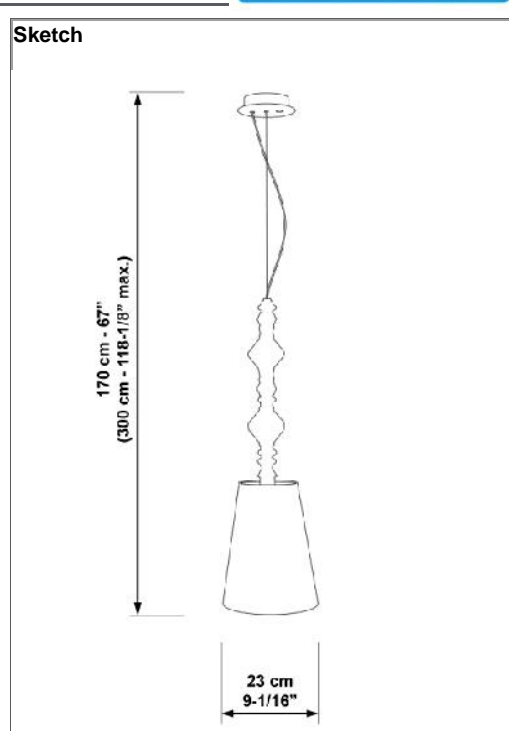
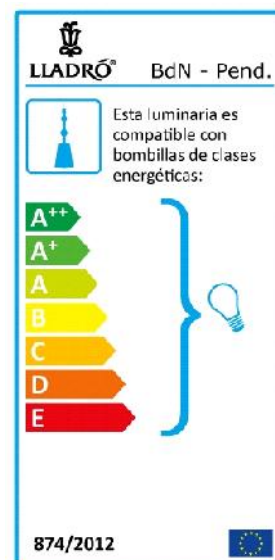

Technical data sheet

CE: Ref 01023403 - UPC/EAN 737859234033
UK: Ref 01023404 - UPC/EAN 737859234033
US: Ref 01023405 - UPC/EAN 737859234033
JP: Ref 01023406 - UPC/EAN 737859234033

Description:	Belle de Nuit - Floor Lamp I - blue Belle de Nuit - Lámpara de pie I - azul
Collection:	BELLE DE NUIT
Mounting:	Floor lamp
Environment:	Standing lamp body made of porcelain. Available in different finishes to match all decorative ambiances. This model fits well alone or in combination with other items from the same collection
Installation and assembly:	Follow instructions of the installation guide
Electrical characteristics:	Max. Power: 1 x 18W Tension: CE-UK: 220/240VAC US-JP: 100/125VAC Frequency: 50/60Hz
Recommended Bulb	Bulb not included Bulb reference CE: 1 x E27 LED 6W (600 Lm) US: 1 x E26 LED 6W (600 Lm)
Certificates:	CE, SASO UL
Physical characteristics:	1 Box / 35 x 33 x 193 cm / 0,223 m3 1 Box / 13 3/4 x 13 x 76 inches / 13585 in3 Gross weight 7,7 Kg. / Net weight 3,9 Kg.



Sketch

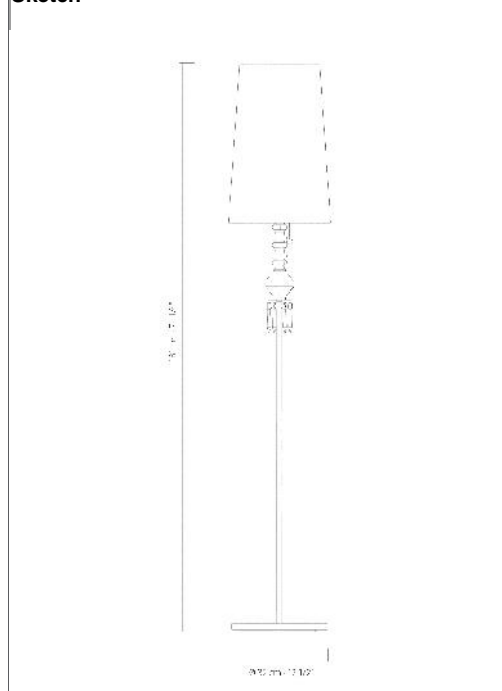

Technical data sheet

CE:	Ref 01023407 - UPC/EAN 737859234071
UK:	Ref 01023408 - UPC/EAN 737859234071
US:	Ref 01023409 - UPC/EAN 737859234071
JP:	Ref 01023410 - UPC/EAN 737859234071

Description:	Belle de Nuit - Floor Lamp II - blue Belle de Nuit - Lámpara de pie II - azul
Collection:	BELLE DE NUIT
Mounting:	Floor lamp
Environment:	Standing lamp body made of porcelain. Available in different finishes to match all decorative ambiances. This model fits well alone or in combination with other items from the same collection
Installation and assembly:	Follow instructions of the installation guide
Electrical characteristics:	Max. Power: 1 x 18W Tension: CE-UK: 220/240VAC US-JP: 100/125VAC Frequency: 50/60Hz
Recommended Bulb	Bulb not included Bulb reference CE: 1 x E27 LED 6W (600 Lm) US: 1 x E26 LED 6W (600 Lm)
Certificates:	CE, SASO UL
Physical characteristics:	1 Box / 35 x 33 x 193 cm / 0,223 m3 1 Box / 13 3/4 x 13 x 76 inches / 13585 in3 Gross weight 8,6 Kg. / Net weight 4,2 Kg.

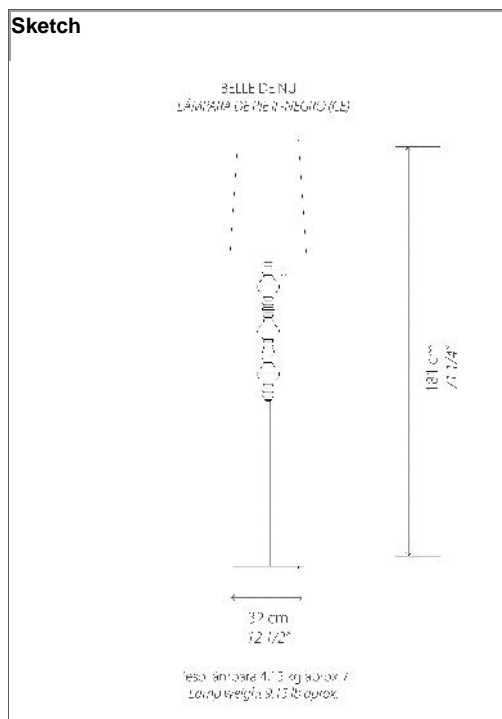

Technical data sheet

CE: Ref 01023411 - UPC/EAN 737859234118
UK: Ref 01023411 - UPC/EAN 737859234118
US: Ref 01023412 - UPC/EAN 737859234118
JP: Ref 01023413 - UPC/EAN 737859234118

Description:

Belle de Nuit - lithophane hanging lamp - blue
Belle de Nuit - Lámpara litofanía colgante - azul

Collection:

BELLE DE NUIT

Mounting:

Pendant

Environment:

Both hanging lamp body and lampshade are made of porcelain. Available in different finishes to match all decorative ambiances. Easy to fix to ceiling system and capable of changing length during installation. This model fits well on a corner display

Installation and assembly:

Follow instructions of the installation guide

Electrical characteristics:

Max. Power: 1 x 18W
Tension: CE-UK: 220/240VAC US-JP: 100/125VAC
Frequency: 50/60Hz

Recommended Bulb

Bulb not included	Bulb reference
CE: 1 x G9 LED 3W 220V (190Lm)	01089407
US: 1 x G9 LED 3W 110V (190Lm)	

Certificates:

CE, SASO

Physical characteristics:

1 Box / 17,9 x 24,9 x 42,3 cm / 0,019 m3
 1 Box / 7 x 9 3/4 x 16 3/4 inches / 1143 in3
 Gross weight 1,7 Kg. / Net weight 0,8 Kg.



Sketch

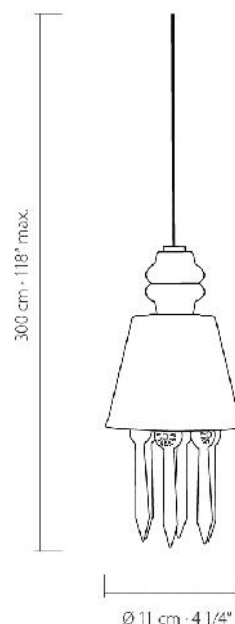

Technical data sheet

CE: Ref 01023414 - UPC/EAN 737859234149
UK: Ref 01023414 - UPC/EAN 737859234149
US: Ref 01023415 - UPC/EAN 737859234149
JP: Ref 01023416 - UPC/EAN 737859234149

Description:

Belle de Nuit - pendant lamp I - pink
Belle de Nuit - Lámpara de techo I - rosa

Collection:

BELLE DE NUIT

Mounting:

Pendant

Environment:

Hanging lamp body made of porcelain. Available in different finishes to match all decorative ambiances. Easy to fix to ceiling system and capable of changing length during installation. This model fits well on a corner display but also on reception desks.

Installation and assembly:

Follow instructions of the installation guide

Electrical characteristics:

Max. Power: 1 x 18W
Tension: CE-UK: 220/240VAC US-JP: 100/125VAC
Frequency: 50/60Hz
 Dimmer not included

Recommended Bulb

Bulb not included	Bulb reference
CE: 1 x E27 LED 6W (600 Lm)	01089432
US: 1 x E26 LED 6W (600 Lm)	

Certificates:

CE, SASO
 UL

Physical characteristics:

1 Box / 9,153 x 100 x 100 cm / 0,092 m3
 1 Box / 3 1/2 x 39 1/4 x 39 1/4 inches / 5392 in3
 Gross weight 3,3 Kg. / Net weight 1,2 Kg.

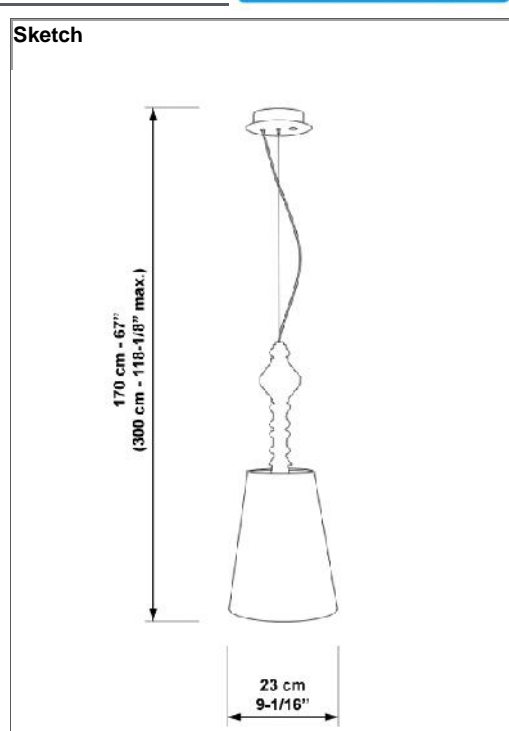
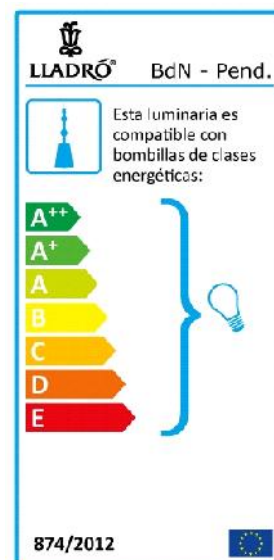

Technical data sheet

CE: Ref 01023417 - UPC/EAN 737859234170
UK: Ref 01023417 - UPC/EAN 737859234170
US: Ref 01023418 - UPC/EAN 737859234170
JP: Ref 01023419 - UPC/EAN 737859234170

Description:

Belle de Nuit - pendant lamp II - pink
Belle de Nuit - Lámpara de techo II - rosa

Collection:

BELLE DE NUIT

Mounting:

Pendant

Environment:

Hanging lamp body made of porcelain. Available in different finishes to match all decorative ambiances. Easy to fix to ceiling system and capable of changing length during installation. This model fits well on a corner display but also on reception desks.

Installation and assembly:

Follow instructions of the installation guide

Electrical characteristics:

Max. Power: 1 x 18W
Tension: CE-UK: 220/240VAC US-JP: 100/125VAC
Frequency: 50/60Hz

Recommended Bulb

Bulb not included	Bulb reference
CE: 1 x E27 LED 6W (600 Lm)	01089432
US: 1 x E26 LED 6W (600 Lm)	

Certificates:

CE, SASO, CCC
 UL

Physical characteristics:

1 Box / 10,694 x 100 x 100 cm / 0,107 m3
 1 Box / 4 1/4 x 39 1/4 x 39 1/4 inches / 6547 in3
 Gross weight 4,1 Kg. / Net weight 1,8 Kg.

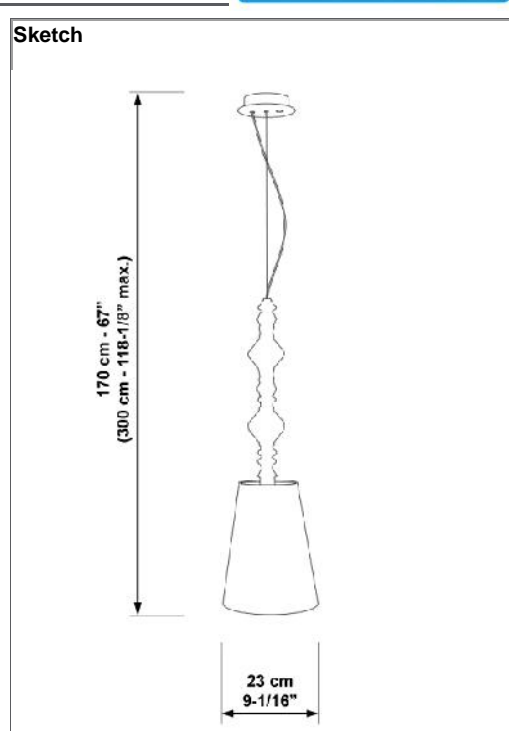
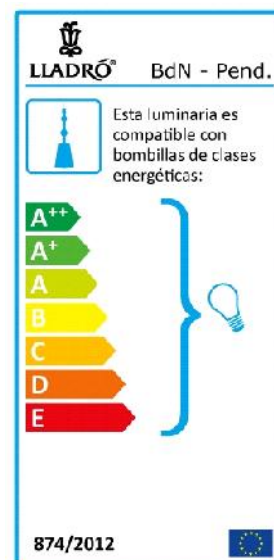

Technical data sheet

CE: Ref 01023420 - UPC/EAN 737859234200
UK: Ref 01023421 - UPC/EAN 737859234200
US: Ref 01023422 - UPC/EAN 737859234200
JP: Ref 01023423 - UPC/EAN 737859234200

Description:

Belle de Nuit - Floor Lamp I - pink
Belle de Nuit - Lámpara de pie I - rosa

Collection:

BELLE DE NUIT

Mounting:

Floor lamp

Environment:

Standing lamp body made of porcelain. Available in different finishes to match all decorative ambiances. This model fits well alone or in combination with other items from the same collection

Installation and assembly:

Follow instructions of the installation guide

Electrical characteristics:

Max. Power: 1 x 18W
Tension: CE-UK: 220/240VAC US-JP: 100/125VAC
Frequency: 50/60Hz

Recommended Bulb

Bulb not included **Bulb reference**
CE: 1 x E27 LED 6W (600 Lm)
US: 1 x E26 LED 6W (600 Lm)

Certificates:

CE, SASO
 UL

Physical characteristics:

1 Box / 35 x 33 x 193 cm / 0,223 m3
 1 Box / 13 3/4 x 13 x 76 inches / 13585 in3
 Gross weight 7,7 Kg. / Net weight 3,9 Kg.



Sketch

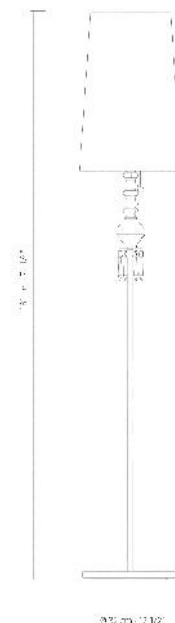

Technical data sheet

CE:	Ref 01023424 - UPC/EAN 737859234248
UK:	Ref 01023425 - UPC/EAN 737859234248
US:	Ref 01023426 - UPC/EAN 737859234248
JP:	Ref 01023427 - UPC/EAN 737859234248

Description:	Belle de Nuit - Floor Lamp II - pink Belle de Nuit - Lámpara de pie II - rosa
Collection:	BELLE DE NUIT
Mounting:	Floor lamp
Environment:	Standing lamp body made of porcelain. Available in different finishes to match all decorative ambiances. This model fits well alone or in combination with other items from the same collection
Installation and assembly:	Follow instructions of the installation guide
Electrical characteristics:	Max. Power: 1 x 18W Tension: CE-UK: 220/240VAC US-JP: 100/125VAC Frequency: 50/60Hz
Recommended Bulb	Bulb not included Bulb reference CE: 1 x E27 LED 6W (600 Lm) US: 1 x E26 LED 6W (600 Lm)
Certificates:	CE, SASO UL
Physical characteristics:	1 Box / 35 x 33 x 193 cm / 0,223 m3 1 Box / 13 3/4 x 13 x 76 inches / 13585 in3 Gross weight 8,6 Kg. / Net weight 4,2 Kg.

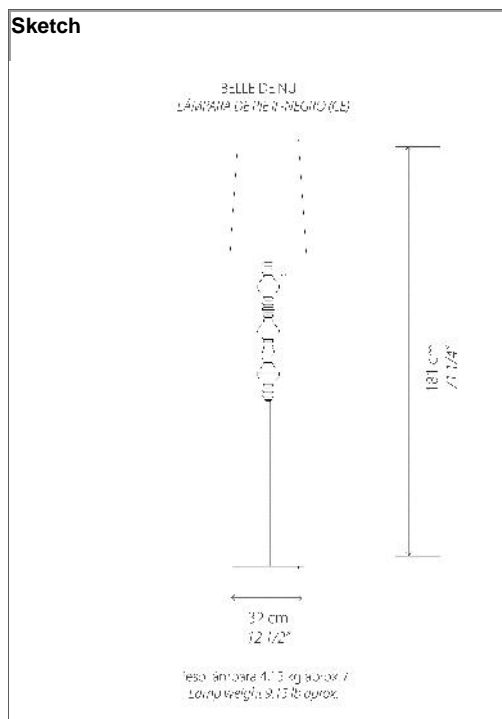

Technical data sheet

CE: Ref 01023428 - UPC/EAN 737859234286
UK: Ref 01023428 - UPC/EAN 737859234286
US: Ref 01023429 - UPC/EAN 737859234286
JP: Ref 01023430 - UPC/EAN 737859234286

Description:

Belle de Nuit - lithophane hanging lamp - pink
Belle de Nuit - Lámpara litofanía colgante - rosa

Collection:

BELLE DE NUIT

Mounting:

Pendant

Environment:

Both hanging lamp body and lampshade are made of porcelain. Available in different finishes to match all decorative ambiances. Easy to fix to ceiling system and capable of changing length during installation. This model fits well on a corner display

Installation and assembly:

Follow instructions of the installation guide

Electrical characteristics:

Max. Power: 1 x 18W
Tension: CE-UK: 220/240VAC US-JP: 100/125VAC
Frequency: 50/60Hz
 Dimmer not included

Recommended Bulb

Bulb not included	Bulb reference
CE: 1 x G9 LED 3W 220V (190Lm)	01089407
US: 1 x G9 LED 3W 110V (190Lm)	

Certificates:

CE, SASO

Physical characteristics:

1 Box / 17,9 x 24,9 x 42,3 cm / 0,019 m3
 1 Box / 7 x 9 3/4 x 16 3/4 inches / 1143 in3
 Gross weight 1,7 Kg. / Net weight 0,8 Kg.



Sketch

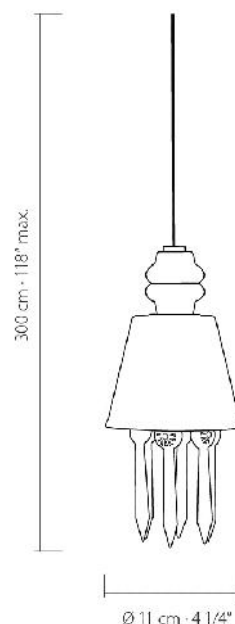

Technical data sheet

CE: Ref 01023431 - UPC/EAN 737859234316
UK: Ref 01023431 - UPC/EAN 737859234316
US: Ref 01023432 - UPC/EAN 737859234316
JP: Ref 01023433 - UPC/EAN 737859234316

Description:

Belle de Nuit - pendant lamp I - multicolor
Belle de Nuit - Lámpara de techo I - multicolor

Collection:

BELLE DE NUIT

Mounting:

Pendant

Environment:

Hanging lamp body made of porcelain. Available in different finishes to match all decorative ambiances. Easy to fix to ceiling system and capable of changing length during installation. This model fits well on a corner display but also on reception desks.

Installation and assembly:

Follow instructions of the installation guide

Electrical characteristics:

Max. Power: 1 x 18W
Tension: CE-UK: 220/240VAC US-JP: 100/125VAC
Frequency: 50/60Hz
 Dimmer not included

Recommended Bulb

Bulb not included	Bulb reference
CE: 1 x E27 LED 6W (600 Lm)	01089432
US: 1 x E26 LED 6W (600 Lm)	

Certificates:

CE, SASO
UL

Physical characteristics:

1 Box / 9,153 x 100 x 100 cm / 0,092 m3
 1 Box / 3 1/2 x 39 1/4 x 39 1/4 inches / 5392 in3
 Gross weight 3,3 Kg. / Net weight 1,2 Kg.

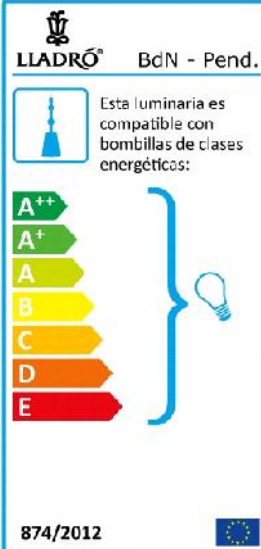

LLADRÓ BdN - Pend.
 Esta luminaria es compatible con bombillas de clases energéticas:
 A++
 A+
 A
 B
 C
 D
 E
 874/2012

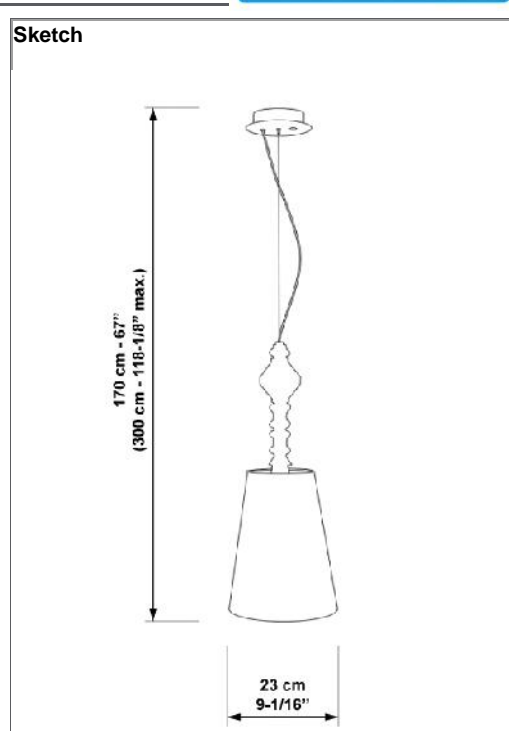

Technical data sheet

CE: Ref 01023434 - UPC/EAN 737859234347
UK: Ref 01023434 - UPC/EAN 737859234347
US: Ref 01023435 - UPC/EAN 737859234347
JP: Ref 01023436 - UPC/EAN 737859234347

Description:

Belle de Nuit - pendant lamp II - multicolor
Belle de Nuit - Lámpara de techo II - multicolor

Collection:

BELLE DE NUIT

Mounting:

Pendant

Environment:

Hanging lamp body made of porcelain. Available in different finishes to match all decorative ambiances. Easy to fix to ceiling system and capable of changing length during installation. This model fits well on a corner display but also on reception desks.

Installation and assembly:

Follow instructions of the installation guide

Electrical characteristics:

Max. Power: 1 x 18W
Tension: CE-UK: 220/240VAC US-JP: 100/125VAC
Frequency: 50/60Hz
 Dimmer not included

Recommended Bulb

Bulb not included	Bulb reference
CE: 1 x E27 LED 6W (600 Lm)	01089432
US: 1 x E26 LED 6W (600 Lm)	

Certificates:

CE, SASO
UL

Physical characteristics:

1 Box / 10,694 x 100 x 100 cm / 0,107 m3
 1 Box / 4 1/4 x 39 1/4 x 39 1/4 inches / 6547 in3
 Gross weight 4,1 Kg. / Net weight 1,8 Kg.



Sketch

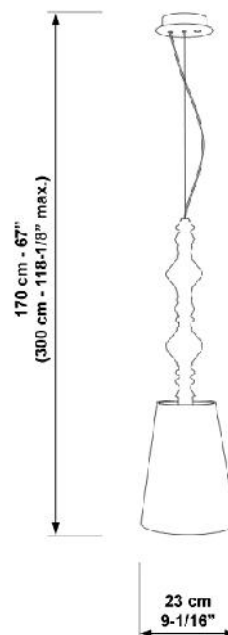

Technical data sheet

CE: Ref 01023437 - UPC/EAN 737859234378
UK: Ref 01023438 - UPC/EAN 737859234378
US: Ref 01023439 - UPC/EAN 737859234378
JP: Ref 01023440 - UPC/EAN 737859234378

Description:

Belle de Nuit - Floor Lamp I - multicolor
Belle de Nuit - Lámpara de pie I - multicolor

Collection:

BELLE DE NUIT

Mounting:

Floor lamp

Environment:

Standing lamp body made of porcelain. Available in different finishes to match all decorative ambiances. This model fits well alone or in combination with other items from the same collection

Installation and assembly:

Follow instructions of the installation guide

Electrical characteristics:

Max. Power: 1 x 18W
Tension: CE-UK: 220/240VAC US-JP: 100/125VAC
Frequency: 50/60Hz

Recommended Bulb

Bulb not included **Bulb reference**
CE: 1 x E27 LED 6W (600 Lm)
US: 1 x E26 LED 6W (600 Lm)

Certificates:

CE, SASO
 UL

Physical characteristics:

1 Box / 35 x 33 x 193 cm / 0,223 m3
 1 Box / 13 3/4 x 13 x 76 inches / 13585 in3
 Gross weight 7,7 Kg. / Net weight 3,9 Kg.



Sketch

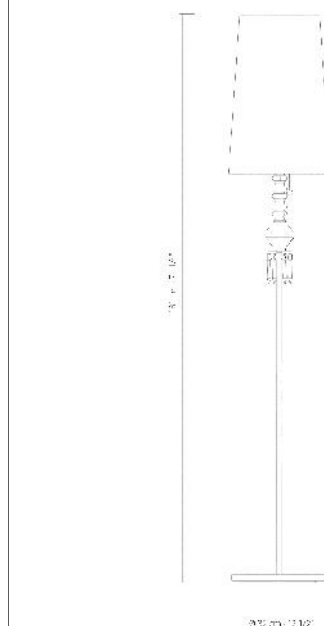

Technical data sheet

CE: Ref 01023441 - UPC/EAN 737859234415
UK: Ref 01023442 - UPC/EAN 737859234415
US: Ref 01023443 - UPC/EAN 737859234415
JP: Ref 01023444 - UPC/EAN 737859234415

Description:

Belle de Nuit - Floor Lamp II - multicolor
Belle de Nuit - Lámpara de pie II - multicolor

Collection:

BELLE DE NUIT

Mounting:

Floor lamp

Environment:

Standing lamp body made of porcelain. Available in different finishes to match all decorative ambiances. This model fits well alone or in combination with other items from the same collection

Installation and assembly:

Follow instructions of the installation guide

Electrical characteristics:

Max. Power: 1 x 18W
Tension: CE-UK: 220/240VAC US-JP: 100/125VAC
Frequency: 50/60Hz

Recommended Bulb

Bulb not included **Bulb reference**
CE: 1 x E27 LED 6W (600 Lm)
US: 1 x E26 LED 6W (600 Lm)

Certificates:

CE, SASO
 UL

Physical characteristics:

1 Box / 35 x 33 x 193 cm / 0,223 m3
 1 Box / 13 3/4 x 13 x 76 inches / 13585 in3
 Gross weight 8,6 Kg. / Net weight 4,2 Kg.



Sketch

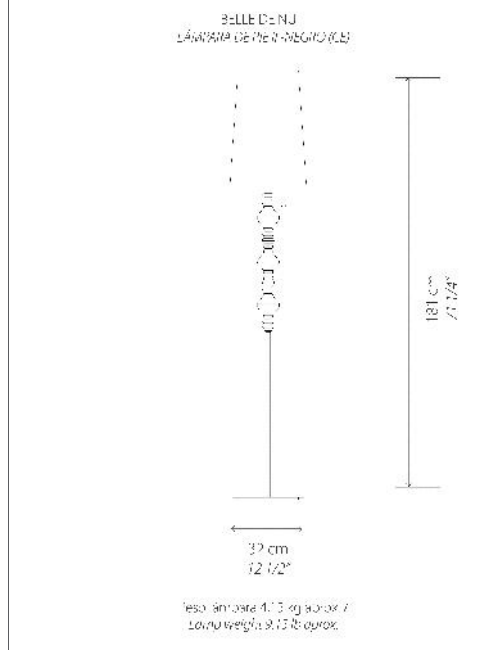

Technical data sheet

CE: Ref 01023445 - UPC/EAN 737859234453
UK: Ref 01023445 - UPC/EAN 737859234453
US: Ref 01023446 - UPC/EAN 737859234453
JP: Ref 01023447 - UPC/EAN 737859234453

Description:

Belle de Nuit - lithophane hanging lamp - multicolor
Belle de Nuit - Lámpara litofanía colgante - multicolor

Collection:

BELLE DE NUIT

Mounting:

Pendant

Environment:

Both hanging lamp body and lampshade are made of porcelain. Available in different finishes to match all decorative ambiances. Easy to fix to ceiling system and capable of changing length during installation. This model fits well on a corner display

Installation and assembly:

Follow instructions of the installation guide

Electrical characteristics:

Max. Power: 1 x 18W
Tension: CE-UK: 220/240VAC US-JP: 100/125VAC
Frequency: 50/60Hz

Recommended Bulb

Bulb not included **Bulb reference**
CE: 1 x G9 LED 3W 220V (190Lm)
US: 1 x G9 LED 3W 110V (190Lm)

Certificates:

Physical characteristics:

1 Box / 17,9 x 24,9 x 42,3 cm / 0,019 m3
 1 Box / 7 x 9 3/4 x 16 3/4 inches / 1143 in3
 Gross weight 1,7 Kg. / Net weight 0,8 Kg.



Sketch

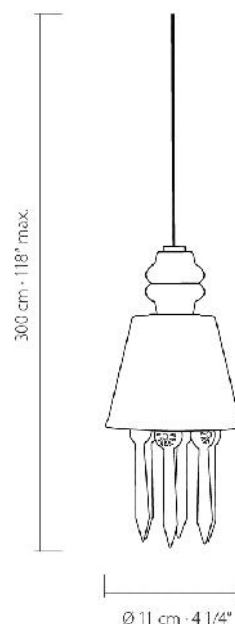

Technical data sheet

CE: Ref 01023448 - UPC/EAN 737859234484
UK: Ref 01023448 - UPC/EAN 737859234484
US: Ref 01023449 - UPC/EAN 737859234484
JP: Ref 01023450 - UPC/EAN 737859234484

Description:

Belle de Nuit - pendant lamp I - gold
Belle de Nuit - Lámpara de techo I - oro

Collection:

BELLE DE NUIT

Mounting:

Pendant

Environment:

Hanging lamp body made of porcelain. Available in different finishes to match all decorative ambiances. Easy to fix to ceiling system and capable of changing length during installation. This model fits well on a corner display but also on reception desks.

Installation and assembly:

Follow instructions of the installation guide

Electrical characteristics:

Max. Power: 1 x 18W
Tension: CE-UK: 220/240VAC US-JP: 100/125VAC
Frequency: 50/60Hz
 Dimmer not included

Recommended Bulb

Bulb not included	Bulb reference
CE: 1 x E27 LED 6W (600 Lm)	01089432
US: 1 x E26 LED 6W (600 Lm)	

Certificates:

CE, SASO
UL

Physical characteristics:

1 Box / 9,153 x 100 x 100 cm / 0,092 m3
 1 Box / 3 1/2 x 39 1/4 x 39 1/4 inches / 5392 in3
 Gross weight 3,3 Kg. / Net weight 1,2 Kg.

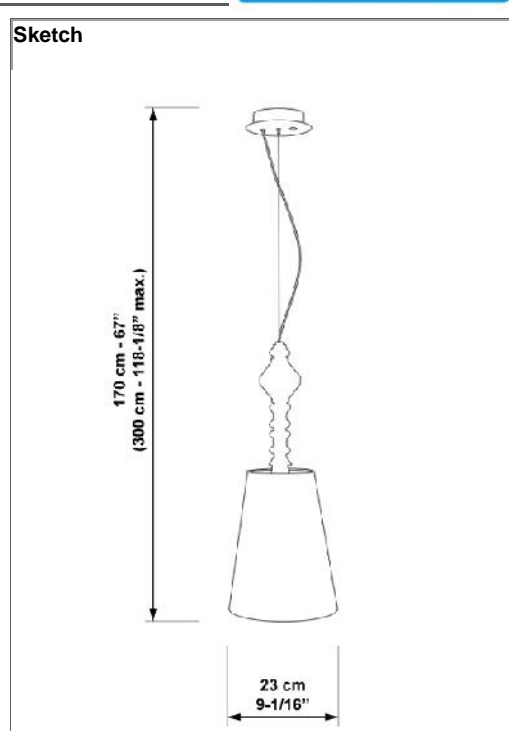
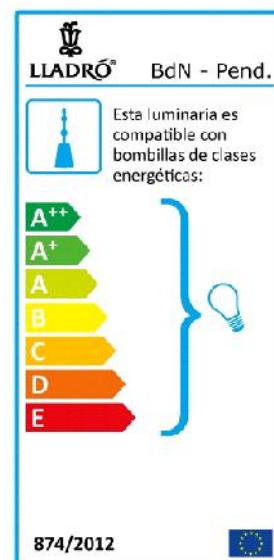

Technical data sheet

CE: Ref 01023451 - UPC/EAN 737859234514
UK: Ref 01023451 - UPC/EAN 737859234514
US: Ref 01023452 - UPC/EAN 737859234514
JP: Ref 01023453 - UPC/EAN 737859234514

Description:

Belle de Nuit - pendant lamp II - gold
Belle de Nuit - Lámpara de techo II - oro

Collection:

BELLE DE NUIT

Mounting:

Pendant

Environment:

Hanging lamp body made of porcelain. Available in different finishes to match all decorative ambiances. Easy to fix to ceiling system and capable of changing length during installation. This model fits well on a corner display but also on reception desks.

Installation and assembly:

Follow instructions of the installation guide

Electrical characteristics:

Max. Power: 1 x 18W
Tension: CE-UK: 220/240VAC US-JP: 100/125VAC
Frequency: 50/60Hz

Recommended Bulb

Bulb not included	Bulb reference
CE: 1 x E27 LED 6W (600 Lm)	01089432
US: 1 x E26 LED 6W (600 Lm)	

Certificates:

CE, SASO, CCC
 UL

Physical characteristics:

1 Box / 10,694 x 100 x 100 cm / 0,107 m3
 1 Box / 4 1/4 x 39 1/4 x 39 1/4 inches / 6547 in3
 Gross weight 4,1 Kg. / Net weight 1,8 Kg.

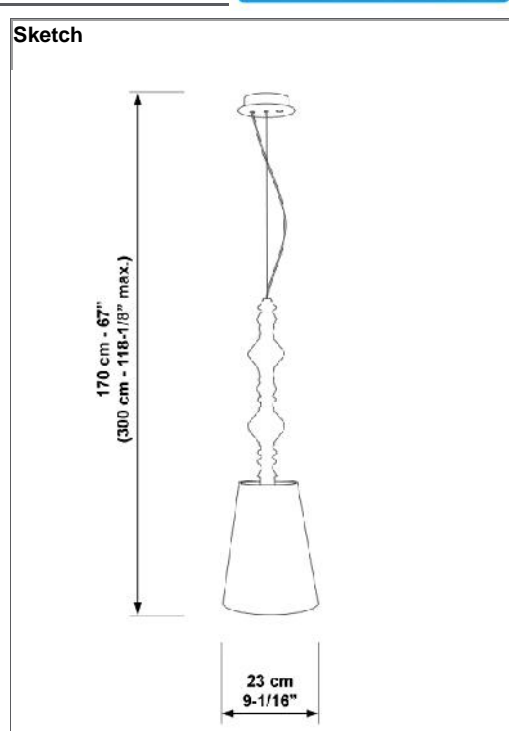
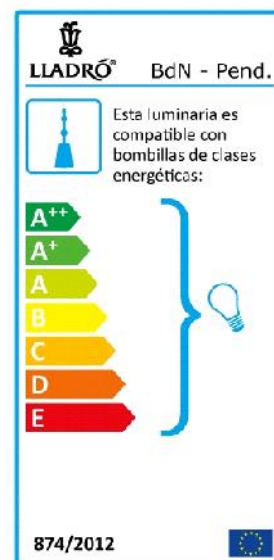

Technical data sheet

CE: Ref 01023454 - UPC/EAN 737859234545
UK: Ref 01023455 - UPC/EAN 737859234545
US: Ref 01023456 - UPC/EAN 737859234545
JP: Ref 01023457 - UPC/EAN 737859234545

Description:

Belle de Nuit - Floor Lamp I - gold
Belle de Nuit - Lámpara de pie I - oro

Collection:

BELLE DE NUIT

Mounting:

Floor lamp

Environment:

Standing lamp body made of porcelain. Available in different finishes to match all decorative ambiances. This model fits well alone or in combination with other items from the same collection

Installation and assembly:

Follow instructions of the installation guide

Electrical characteristics:

Max. Power: 1 x 18W
Tension: CE-UK: 220/240VAC US-JP: 100/125VAC
Frequency: 50/60Hz

Recommended Bulb

Bulb not included **Bulb reference**
CE: 1 x E27 LED 6W (600 Lm)
US: 1 x E26 LED 6W (600 Lm)

Certificates:

CE, SASO
 UL

Physical characteristics:

1 Box / 35 x 33 x 193 cm / 0,223 m3
 1 Box / 13 3/4 x 13 x 76 inches / 13585 in3
 Gross weight 7,7 Kg. / Net weight 3,9 Kg.



Sketch

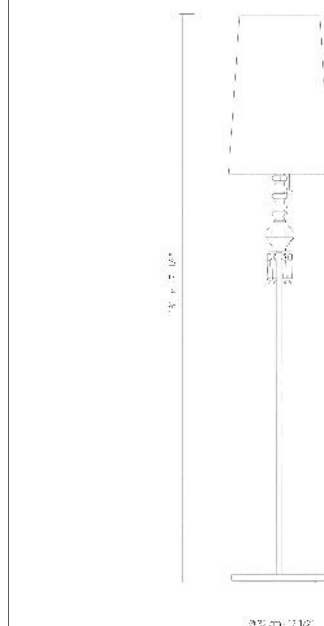

Technical data sheet

CE:	Ref 01023458 - UPC/EAN 737859234583
UK:	Ref 01023459 - UPC/EAN 737859234583
US:	Ref 01023460 - UPC/EAN 737859234583
JP:	Ref 01023461 - UPC/EAN 737859234583

Description:	Belle de Nuit - Floor Lamp II - gold Belle de Nuit - Lámpara de pie II - oro
Collection:	BELLE DE NUIT
Mounting:	Floor lamp
Environment:	Standing lamp body made of porcelain. Available in different finishes to match all decorative ambiances. This model fits well alone or in combination with other items from the same collection
Installation and assembly:	Follow instructions of the installation guide
Electrical characteristics:	Max. Power: 1 x 18W Tension: CE-UK: 220/240VAC US-JP: 100/125VAC Frequency: 50/60Hz
Recommended Bulb	Bulb not included Bulb reference CE: 1 x E27 LED 6W (600 Lm) US: 1 x E26 LED 6W (600 Lm)
Certificates:	CE, SASO UL
Physical characteristics:	1 Box / 35 x 33 x 193 cm / 0,223 m3 1 Box / 13 3/4 x 13 x 76 inches / 13585 in3 Gross weight 8,6 Kg. / Net weight 4,2 Kg.



Sketch

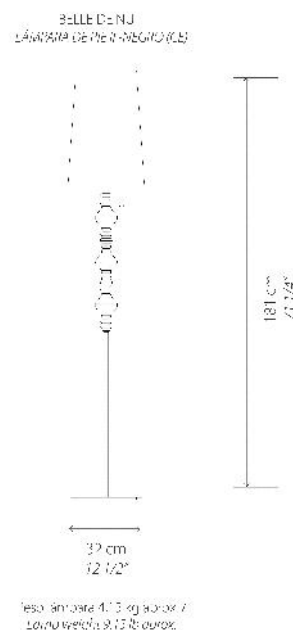

Technical data sheet

CE:	Ref 01023462 - UPC/EAN 737859234620
UK:	Ref 01023462 - UPC/EAN 737859234620
US:	Ref 01023463 - UPC/EAN 737859234620
JP:	Ref 01023464 - UPC/EAN 737859234620

Description:	Belle de Nuit - lithophane hanging lamp - gold Belle de Nuit - Lámpara litofanía colgante - oro						
Collection:	BELLE DE NUIT						
Mounting:	Pendant						
Environment:	Both hanging lamp body and lampshade are made of porcelain. Available in different finishes to match all decorative ambiances. Easy to fix to ceiling system and capable of changing length during installation. This model fits well on a corner display						
Installation and assembly:	Follow instructions of the installation guide						
Electrical characteristics:	<p>Max. Power: 1 x 18W</p> <p>Tension: CE-UK: 220/240VAC US-JP: 100/125VAC</p> <p>Frequency: 50/60Hz</p>						
Recommended Bulb	<table border="1"> <thead> <tr> <th>Bulb not included</th> <th>Bulb reference</th> </tr> </thead> <tbody> <tr> <td>CE: 1 x G9 LED 3W 220V (190Lm)</td> <td>01089407</td> </tr> <tr> <td>US: 1 x G9 LED 3W 110V (190Lm)</td> <td></td> </tr> </tbody> </table>	Bulb not included	Bulb reference	CE: 1 x G9 LED 3W 220V (190Lm)	01089407	US: 1 x G9 LED 3W 110V (190Lm)	
Bulb not included	Bulb reference						
CE: 1 x G9 LED 3W 220V (190Lm)	01089407						
US: 1 x G9 LED 3W 110V (190Lm)							
Certificates:	CE, SASO						
Physical characteristics:	<p>1 Box / 17,9 x 24,9 x 42,3 cm / 0,019 m³</p> <p>1 Box / 7 x 9 3/4 x 16 3/4 inches / 1143 in³</p> <p>Gross weight 1,7 Kg. / Net weight 0,8 Kg.</p>						

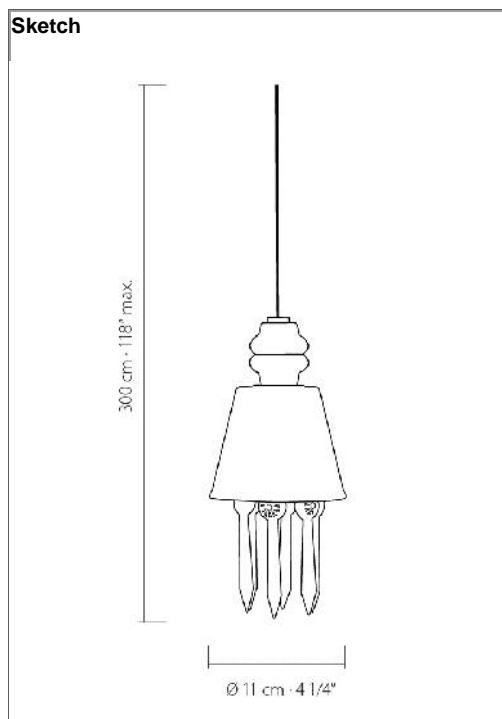

Technical data sheet

CE: Ref 01023746 - UPC/EAN 737859237461
UK: Ref 01023746 - UPC/EAN 737859237461
US: Ref 01023747 - UPC/EAN 737859237461
JP: Ref 01023748 - UPC/EAN 737859237461

Description:

Belle de Nuit - Chandelier 12 lights - absolute black
Belle de Nuit - Chandelier 12 luces - negro absoluto

Collection:

BELLE DE NUIT

Mounting:

Chandelier

Environment:

Chandelier entirely made of porcelain. Made in different finishes to match all decorative ambiences. Not very heavy to simplify its installation. Bespoke measures available under request.

Installation and assembly:

Follow instructions of the installation guide

Electrical characteristics:

Max. Power: 12 x 18W
Tension: CE-UK: 220/240VAC US-JP: 100/125VAC
Frequency: 50/60Hz
 Dimmer not included / LED bulb non dimmable

Recommended Bulb

Bulb not included	Bulb reference
CE: 12 x G9 Led 3W 220V (190Lm)	1089407
US: 12 x G9 Led 3W 110V (190Lm)	

Certificates:

CE, SASO
UL

Physical characteristics:

1 Box / 111 x 82 x 82 cm / 0,746 m3
 1 Box / 43 3/4 x 32 1/4 x 32 1/4 inches / 45503 in3
 Gross weight 36 Kg. / Net weight 8,3 Kg.

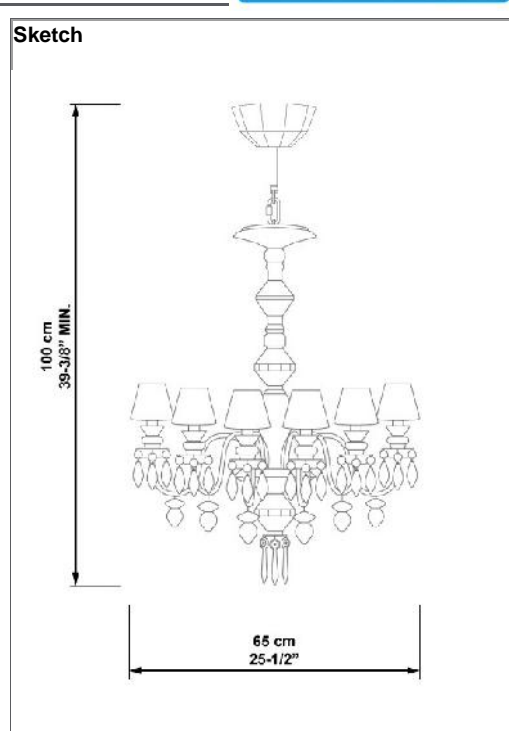

Technical data sheet

CE:	Ref 01023749 - UPC/EAN 737859237492
UK:	Ref 01023749 - UPC/EAN 737859237492
US:	Ref 01023750 - UPC/EAN 737859237492
JP:	Ref 01023751 - UPC/EAN 737859237492

Description:

Belle de Nuit - Chandelier 24 lights - absolute black
Belle de Nuit - Chandelier 24 luces - negro absoluto

Collection:

BELLE DE NUIT

Mounting:

Chandelier

Environment:

Chandelier entirely made of porcelain. Made in different finishes to match all decorative ambiences. Not very heavy to simplify its installation. Bespoke measures available under request.

Installation and assembly:

Follow instructions of the installation guide

Electrical characteristics:

Max. Power: 24 x 18W
Tension: CE-UK: 220/240VAC US-JP: 100/125VAC
Frequency: 50/60Hz
Dimmer not included / LED bulb non dimmable

Recommended Bulb

Bulb not included	Bulb reference
CE: 24 x G9 Led 3W 220V (190Lm)	01089407
US: 24 x G9 Led 3W 110V (190Lm)	

Certificates:

CE, SASO
UL

Physical characteristics:

1 Box / 135 x 105 x 105 cm / 1,488 m3
1 Box / 53 1/4 x 41 1/4 x 41 1/4 inches / 90608 in3
Gross weight 44,1 kg. / Net weight 21,2 kg.

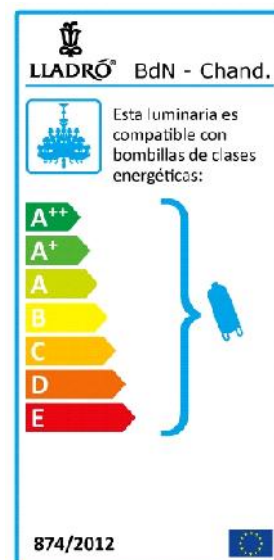

Sketch

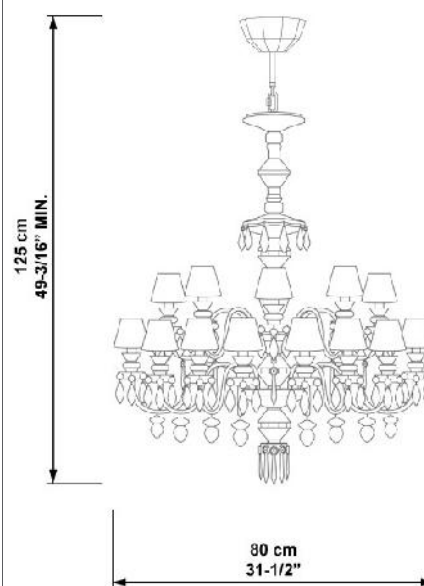

Technical data sheet

CE: Ref 01023752 - UPC/EAN 737859237522
UK: Ref 01023752 - UPC/EAN 737859237522
US: Ref 01023753 - UPC/EAN 737859237522
JP: Ref 01023754 - UPC/EAN 737859237522

Description:

Belle de Nuit - Chandelier 40 lights - absolute black
Belle de Nuit - Chandelier 40 luces - negro absoluto

Collection:

BELLE DE NUIT

Mounting:

Chandelier

Environment:

Chandelier entirely made of porcelain. Made in different finishes to match all decorative ambiances. Not very heavy to simplify its installation. Bespoke measures available under request.

Installation and assembly:

Follow instructions of the installation guide

Electrical characteristics:

Max. Power: 40 x 18W
Tension: CE-UK: 220/240VAC US-JP: 100/125VAC
Frequency: 50/60Hz
 Dimmer not included / LED bulb non dimmable

Recommended Bulb

Bulb not included	Bulb reference
CE: 40 x G9 Led 3W 220V (190Lm)	01089407
US: 40 x G9 Led 3W 110V (190Lm)	

Certificates:

CE, SASO
UL

Physical characteristics:

1 Box / 140 x 119 x 119 cm / 1,983 m3
 1 Box / 55 x 46 3/4 x 46 3/4 inches / 120206 in3
 Gross weight 129,6 kg. / Net weight 27,4 kg.



Sketch

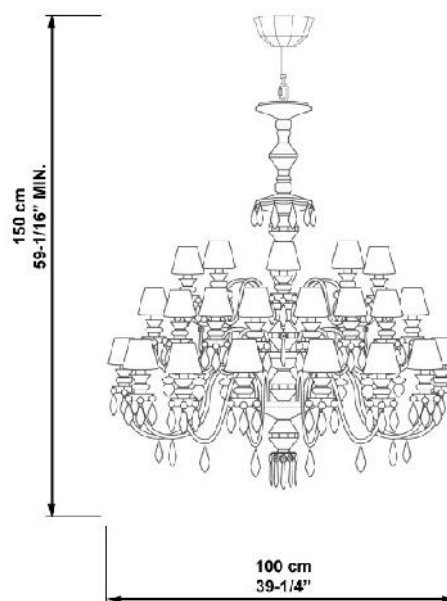

Technical data sheet

CE: Ref 01023768 - UPC/EAN 737859237683
UK: Ref 01023768 - UPC/EAN 737859237683
US: Ref 01023769 - UPC/EAN 737859237683
JP: Ref 01023770 - UPC/EAN 737859237683

Description:

Belle de Nuit - Chandelier 56 lights. White
Belle de Nuit - Chandelier 56 luces. Blanco

Collection:

BELLE DE NUIT

Mounting:

Chandelier

Environment:

Belle de Nuit is a special plant. During the night, its petals seem to reflect the moonlight, and take on the magical property of glowing in the dark. The flower opens in the evening which is why it is also known in English as the four o'clock flower. It has a multitude of colors and mottled flowers with countless nuances. When the plant matures, its colors change and a yellow flower becomes a deep pink while a white flower becomes violet.

Installation and assembly:

Follow instructions of the installation guide

Electrical characteristics:

Max. Power: 56 x 18W
Tension: CE-UK: 220/240VAC US-JP: 100/125VAC
Frequency: 50/60Hz
 Dimmer not included / LED bulb non dimmable

Recommended Bulb

Bulb not included	Bulb reference
CE: 56 x G9 Led 3W 220V (190Lm)	01089407
US: 56 x G9 Led 3W 110V (190Lm)	

Certificates:

CE
UL

Physical characteristics:

1 Box / 265,05 x 100 x 100 cm / 2,65 m3
 1 Box / 104 1/4 x 39 1/4 x 39 1/4 inches / 160604 in3
 Gross weight 200 Kg. / Net weight 48,7 Kg.



LLADRÓ BdN - Chand.

Esta luminaria es compatible con bombillas de clases energéticas:

A++
A+
A
B
C
D
E

874/2012 

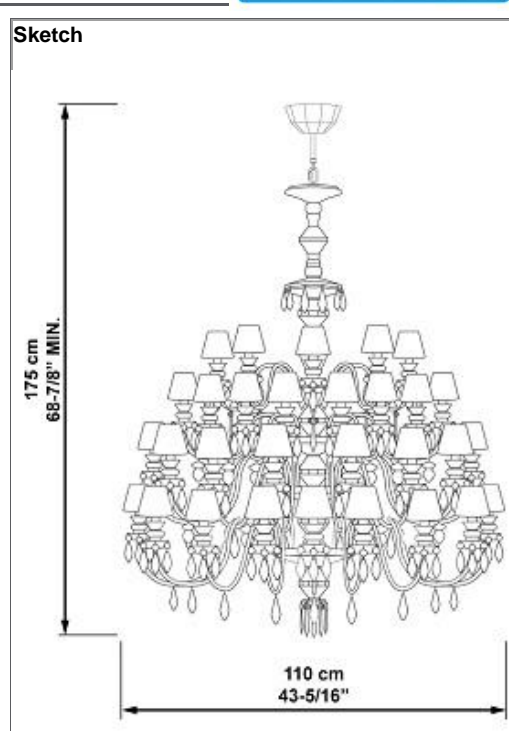

Technical data sheet

CE: Ref 01023771 - UPC/EAN 737859237713
UK: Ref 01023771 - UPC/EAN 737859237713
US: Ref 01023772 - UPC/EAN 737859237713
JP: Ref 01023773 - UPC/EAN 737859237713

Description:

Belle de Nuit - Chandelier 56 lights. Black
Belle de Nuit - Chandelier 56 luces. Negro

Collection:

BELLE DE NUIT

Mounting:

Chandelier

Environment:

Belle de Nuit is a special plant. During the night, its petals seem to reflect the moonlight, and take on the magical property of glowing in the dark. The flower opens in the evening which is why it is also known in English as the four o'clock flower. It has a multitude of colors and mottled flowers with countless nuances. When the plant matures, its colors change and a yellow flower becomes a deep pink while a white flower becomes violet.

Installation and assembly:

Follow instructions of the installation guide

Electrical characteristics:

Max. Power: 56 x 18W
Tension: CE-UK: 220/240VAC US-JP: 100/125VAC
Frequency: 50/60Hz
 Dimmer not included / LED bulb non dimmable

Recommended Bulb

Bulb not included	Bulb reference
CE: 56 x G9 Led 3W 220V (190Lm)	01089407
US: 56 x G9 Led 3W 110V (190Lm)	

Certificates:

CE
UL

Physical characteristics:

1 Box / 265,05 x 100 x 100 cm / 2,65 m3
 1 Box / 104 1/4 x 39 1/4 x 39 1/4 inches / 160604 in3
 Gross weight 200 Kg. / Net weight 48,7 Kg.



Sketch

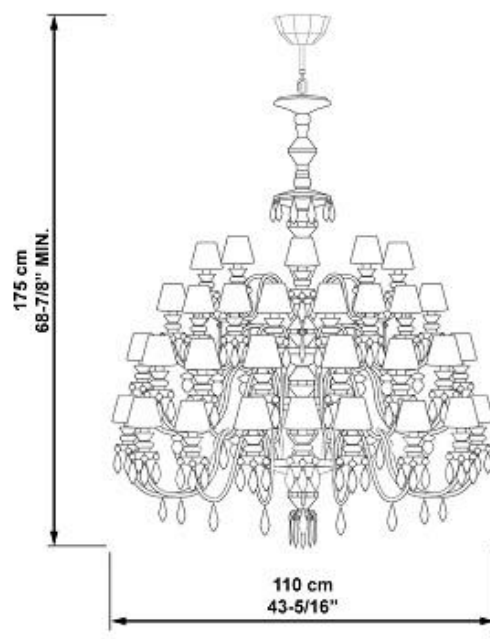

Technical data sheet

CE: Ref 01023774 - UPC/EAN 737859237744
UK: Ref 01023774 - UPC/EAN 737859237744
US: Ref 01023775 - UPC/EAN 737859237744
JP: Ref 01023776 - UPC/EAN 737859237744

Description:

Belle de Nuit - Chandelier 56 lights - green
Belle de Nuit - Chandelier 56 luces - verde

Collection:

BELLE DE NUIT

Mounting:

Chandelier

Environment:

Belle de Nuit is a special plant. During the night, its petals seem to reflect the moonlight, and take on the magical property of glowing in the dark. The flower opens in the evening which is why it is also known in English as the four o'clock flower. It has a multitude of colors and mottled flowers with countless nuances. When the plant matures, its colors change and a yellow flower becomes a deep pink while a white flower becomes violet.

Installation and assembly:

Follow instructions of the installation guide

Electrical characteristics:

Max. Power: 56 x 18W
Tension: CE-UK: 220/240VAC US-JP: 100/125VAC
Frequency: 50/60Hz
 Dimmer not included / LED bulb non dimmable

Recommended Bulb

Bulb not included	Bulb reference
CE: 56 x G9 Led 3W 220V (190Lm)	01089407
US: 56 x G9 Led 3W 110V (190Lm)	

Certificates:

CE
UL

Physical characteristics:

1 Box / 265,05 x 100 x 100 cm / 2,65 m3
 1 Box / 104 1/4 x 39 1/4 x 39 1/4 inches / 160604 in3
 Gross weight 200 Kg. / Net weight 48,7 Kg.

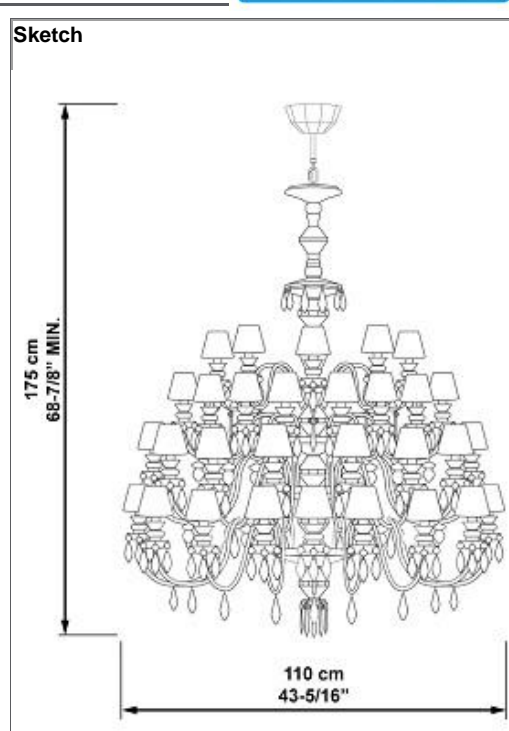
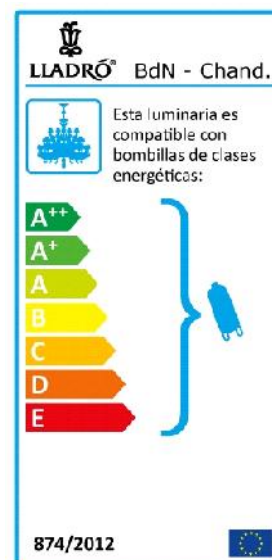

Technical data sheet

CE: Ref 01023777 - UPC/EAN 737859237775
UK: Ref 01023777 - UPC/EAN 737859237775
US: Ref 01023778 - UPC/EAN 737859237775
JP: Ref 01023779 - UPC/EAN 737859237775

Description:

Belle de Nuit - Chandelier 56 lights. Blue
Belle de Nuit - Chandelier 56 luces. Azul

Collection:

BELLE DE NUIT

Mounting:

Chandelier

Environment:

Belle de Nuit is a special plant. During the night, its petals seem to reflect the moonlight, and take on the magical property of glowing in the dark. The flower opens in the evening which is why it is also known in English as the four o'clock flower. It has a multitude of colors and mottled flowers with countless nuances. When the plant matures, its colors change and a yellow flower becomes a deep pink while a white flower becomes violet.

Installation and assembly:

Follow instructions of the installation guide

Electrical characteristics:

Max. Power: 56 x 18W
Tension: CE-UK: 220/240VAC US-JP: 100/125VAC
Frequency: 50/60Hz
 Dimmer not included / LED bulb non dimmable

Recommended Bulb

Bulb not included	Bulb reference
CE: 56 x G9 Led 3W 220V (190Lm)	01089407
US: 56 x G9 Led 3W 110V (190Lm)	

Certificates:

CE
UL

Physical characteristics:

1 Box / 265,05 x 100 x 100 cm / 2,65 m3
 1 Box / 104 1/4 x 39 1/4 x 39 1/4 inches / 160604 in3
 Gross weight 200 Kg. / Net weight 48,7 Kg.

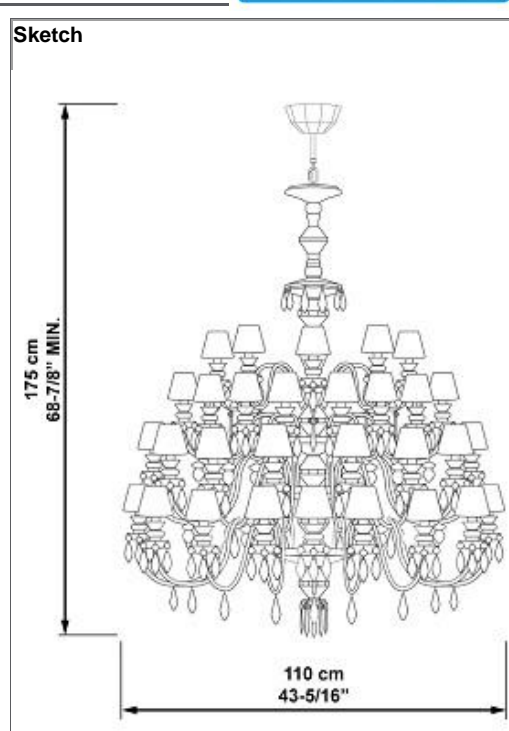
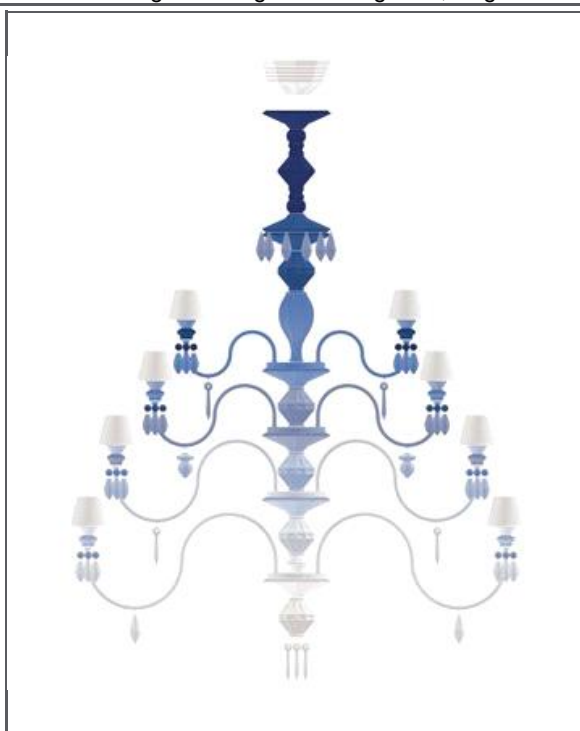
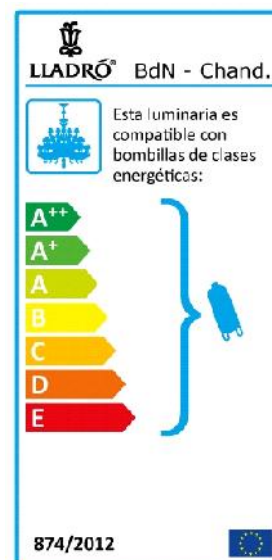

Technical data sheet

CE: Ref 01023780 - UPC/EAN 737859237805
UK: Ref 01023780 - UPC/EAN 737859237805
US: Ref 01023781 - UPC/EAN 737859237805
JP: Ref 01023782 - UPC/EAN 737859237805

Description:

Belle de Nuit - Chandelier 56 lights - pink
Belle de Nuit - Chandelier 56 luces - rosa

Collection:

BELLE DE NUIT

Mounting:

Chandelier

Environment:

Belle de Nuit is a special plant. During the night, its petals seem to reflect the moonlight, and take on the magical property of glowing in the dark. The flower opens in the evening which is why it is also known in English as the four o'clock flower. It has a multitude of colors and mottled flowers with countless nuances. When the plant matures, its colors change and a yellow flower becomes a deep pink while a white flower becomes violet.

Installation and assembly:

Follow instructions of the installation guide

Electrical characteristics:

Max. Power: 56 x 18W
Tension: CE-UK: 220/240VAC US-JP: 100/125VAC
Frequency: 50/60Hz
 Dimmer not included / LED bulb non dimmable

Recommended Bulb

Bulb not included	Bulb reference
CE: 56 x G9 Led 3W 220V (190Lm)	01089407
US: 56 x G9 Led 3W 110V (190Lm)	

Certificates:

CE
UL

Physical characteristics:

1 Box / 265,05 x 100 x 100 cm / 2,65 m3
 1 Box / 104 1/4 x 39 1/4 x 39 1/4 inches / 160604 in3
 Gross weight 200 Kg. / Net weight 48,7 Kg.

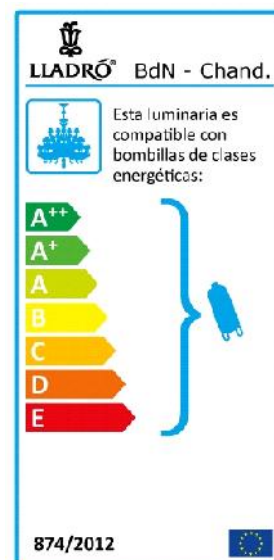

Sketch

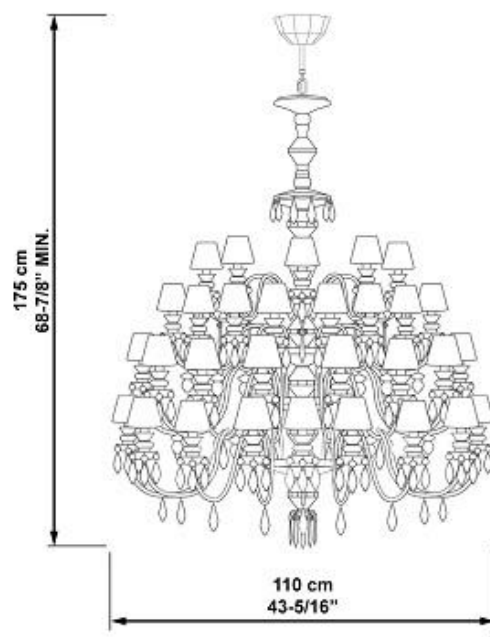

Technical data sheet

CE: Ref 01023783 - UPC/EAN 737859237836
UK: Ref 01023783 - UPC/EAN 737859237836
US: Ref 01023784 - UPC/EAN 737859237836
JP: Ref 01023785 - UPC/EAN 737859237836

Description:

Belle de Nuit - Chandelier 56 lights. Multicolor
Belle de Nuit - Chandelier 56 luces. Multicolor

Collection:

BELLE DE NUIT

Mounting:

Chandelier

Environment:

Belle de Nuit is a special plant. During the night, its petals seem to reflect the moonlight, and take on the magical property of glowing in the dark. The flower opens in the evening which is why it is also known in English as the four o'clock flower. It has a multitude of colors and mottled flowers with countless nuances. When the plant matures, its colors change and a yellow flower becomes a deep pink while a white flower becomes violet.

Installation and assembly:

Follow instructions of the installation guide

Electrical characteristics:

Max. Power: 56 x 18W
Tension: CE-UK: 220/240VAC US-JP: 100/125VAC
Frequency: 50/60Hz
 Dimmer not included / LED bulb non dimmable

Recommended Bulb

Bulb not included	Bulb reference
CE: 56 x G9 Led 3W 220V (190Lm)	01089407
US: 56 x G9 Led 3W 110V (190Lm)	

Certificates:

CE
UL

Physical characteristics:

1 Box / 265,05 x 100 x 100 cm / 2,65 m3
 1 Box / 104 1/4 x 39 1/4 x 39 1/4 inches / 160604 in3
 Gross weight 200 Kg. / Net weight 48,7 Kg.

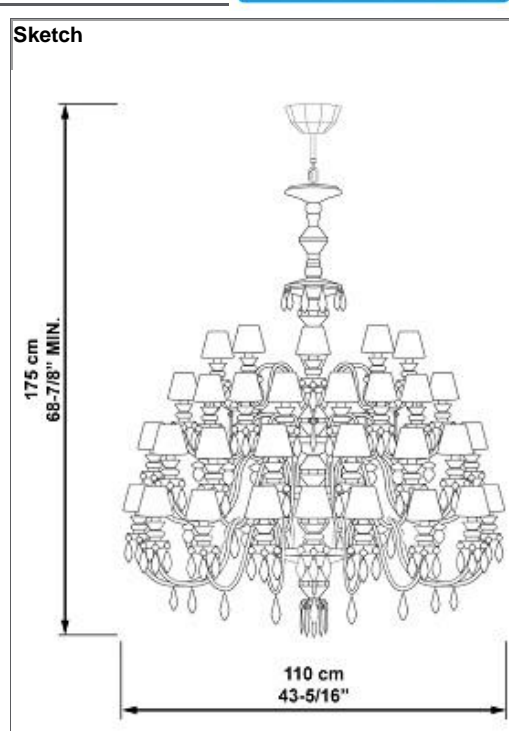
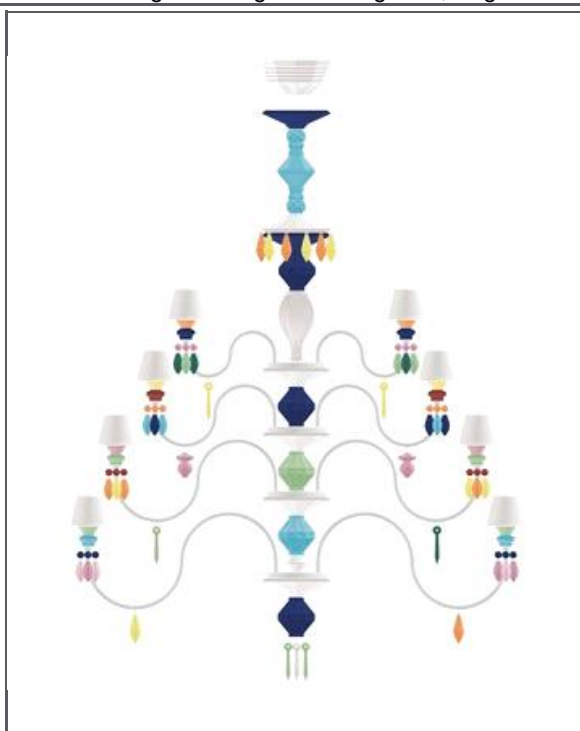

Technical data sheet

CE: Ref 01023786 - UPC/EAN 737859237867
UK: Ref 01023786 - UPC/EAN 737859237867
US: Ref 01023787 - UPC/EAN 737859237867
JP: Ref 01023788 - UPC/EAN 737859237867

Description:

Belle de Nuit - Chandelier 56 lights - gold
Belle de Nuit - Chandelier 56 luces - oro

Collection:

BELLE DE NUIT

Mounting:

Chandelier

Environment:

Belle de Nuit is a special plant. During the night, its petals seem to reflect the moonlight, and take on the magical property of glowing in the dark. The flower opens in the evening which is why it is also known in English as the four o'clock flower. It has a multitude of colors and mottled flowers with countless nuances. When the plant matures, its colors change and a yellow flower becomes a deep pink while a white flower becomes violet.

Installation and assembly:

Follow instructions of the installation guide

Electrical characteristics:

Max. Power: 56 x 18W
Tension: CE-UK: 220/240VAC US-JP: 100/125VAC
Frequency: 50/60Hz
 Dimmer not included / LED bulb non dimmable

Recommended Bulb

Bulb not included	Bulb reference
CE: 56 x G9 Led 3W 220V (190Lm)	01089407
US: 56 x G9 Led 3W 110V (190Lm)	

Certificates:

CE
UL

Physical characteristics:

1 Box / 265,05 x 100 x 100 cm / 2,65 m3
 1 Box / 104 1/4 x 39 1/4 x 39 1/4 inches / 160604 in3
 Gross weight 200 Kg. / Net weight 48,7 Kg.



LLADRÓ BdN - Chand.

Esta luminaria es compatible con bombillas de clases energéticas:

A++
A+
A
B
C
D
E

874/2012 



Sketch

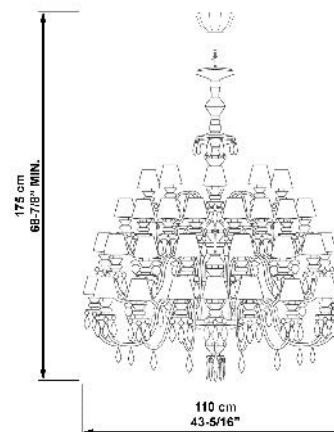

Technical data sheet

CE: Ref 01023789 - UPC/EAN 737859237898
UK: Ref 01023789 - UPC/EAN 737859237898
US: Ref 01023790 - UPC/EAN 737859237898
JP: Ref 01023791 - UPC/EAN 737859237898

Description:

Belle de Nuit - Chandelier 56 lights. Absolute black
Belle de Nuit - Chandelier 56 luces. Negro absoluto

Collection:

BELLE DE NUIT

Mounting:

Chandelier

Environment:

Chandelier entirely made in porcelain. Made in different finishes to be able to match all decorative ambiences. Not very heavy to make more easy its installation. Bespoke measures under request.

Installation and assembly:

Follow instructions of the installation guide

Electrical characteristics:

Max. Power: 56 x 18W
Tension: CE-UK: 220/240VAC US-JP: 100/125VAC
Frequency: 50/60Hz
 Dimmer not included / LED bulb non dimmable

Recommended Bulb

Bulb not included	Bulb reference
CE: 56 x G9 Led 3W 220V (190Lm)	01089407
US: 56 x G9 Led 3W 110V (190Lm)	

Certificates:

CE
UL

Physical characteristics:

1 Box / 265,05 x 100 x 100 cm / 2,65 m3
 1 Box / 104 1/4 x 39 1/4 x 39 1/4 inches / 160604 in3
 Gross weight 200 Kg. / Net weight 48,7 Kg.

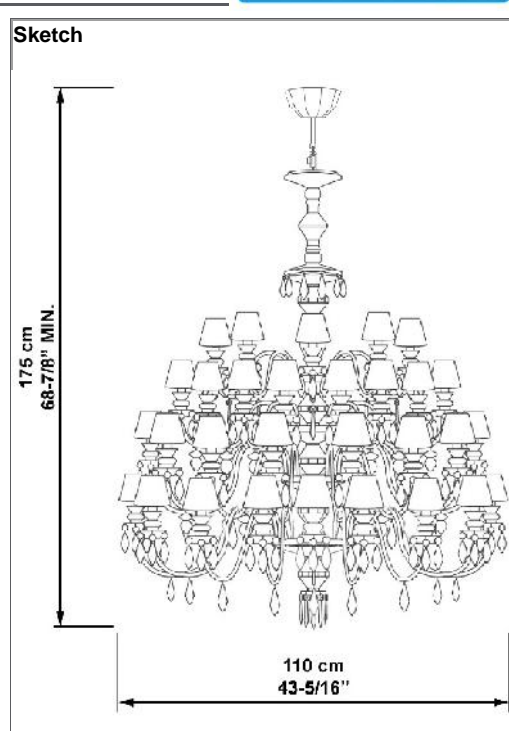
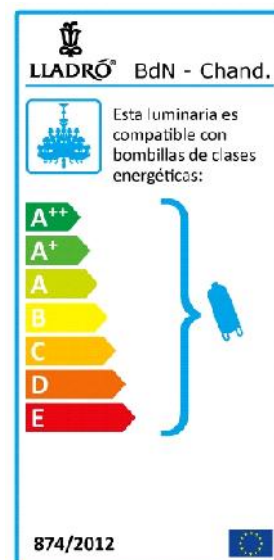

Technical data sheet

CE: Ref 01023795 - UPC/EAN 737859237959
UK: Ref 01023795 - UPC/EAN 737859237959
US: Ref 01023796 - UPC/EAN 737859237959
JP: Ref 01023797 - UPC/EAN 737859237959

Description:

Belle de Nuit - Chandelier 12 lights. Silver
Belle de Nuit - Chandelier 12 luces. Plata

Collection:

BELLE DE NUIT

Mounting:

Chandelier

Environment:

Chandelier entirely made of porcelain. Made in different finishes to match all decorative ambiences. Not very heavy to simplify its installation. Bespoke measures available under request.

Installation and assembly:

Follow instructions of the installation guide

Electrical characteristics:

Max. Power: 12 x 18W
Tension: CE-UK: 220/240VAC US-JP: 100/125VAC
Frequency: 50/60Hz
 Dimmer not included / LED bulb non dimmable

Recommended Bulb

Bulb not included	Bulb reference
CE: 12 x G9 Led 3W 220V (190Lm)	01089407
US: 12 x G9 Led 3W 110V (190Lm)	

Certificates:

CE, SASO
UL

Physical characteristics:

1 Box / 111 x 82 x 82 cm / 0,746 m3
 1 Box / 43 3/4 x 32 1/4 x 32 1/4 inches / 45503 in3
 Gross weight 29,6 Kg. / Net weight 8,3 Kg.

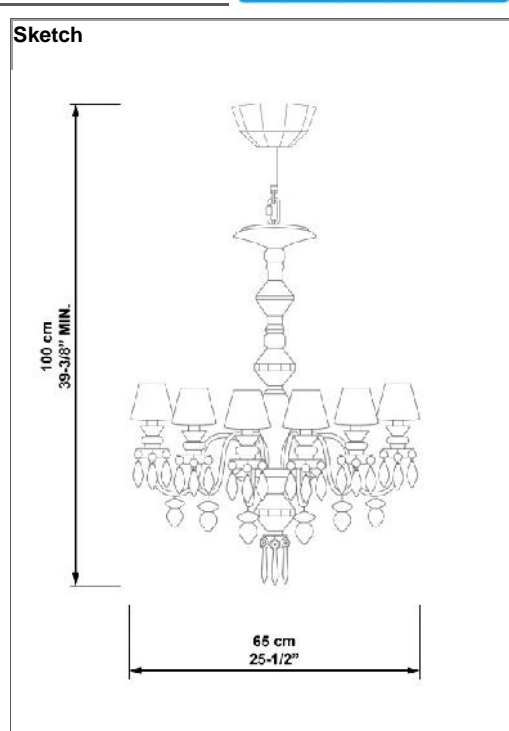
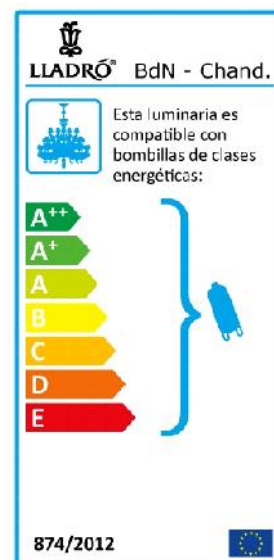

Technical data sheet

CE: Ref 01023913 - UPC/EAN 737859239137
UK: Ref 01023913 - UPC/EAN 737859239137
US: Ref 01023914 - UPC/EAN 737859239137
JP: Ref 01023915 - UPC/EAN 737859239137

Description:

Belle de Nuit - Chandelier 24 lights - silver
Belle de Nuit - Chandelier 24 luces - plata

Collection:

BELLE DE NUIT

Mounting:

Chandelier

Environment:

Chandelier entirely made of porcelain. Made in different finishes to match all decorative ambiences. Not very heavy to simplify its installation. Bespoke measures available under request.

Installation and assembly:

Follow instructions of the installation guide

Electrical characteristics:

Max. Power: 24 x 18W
Tension: CE-UK: 220/240VAC US-JP: 100/125VAC
Frequency: 50/60Hz
 Dimmer not included / LED bulb non dimmable

Recommended Bulb

Bulb not included	Bulb reference
CE: 24 x G9 Led 3W 220V (190Lm)	01089407
US: 24 x G9 Led 3W 110V (190Lm)	

Certificates:

CE, SASO
UL

Physical characteristics:

1 Box / 135 x 105 x 105 cm / 1,488 m3
 1 Box / 53 1/4 x 41 1/4 x 41 1/4 inches / 90608 in3
 Gross weight 44,1 Kg. / Net weight 21,16 Kg.



Sketch

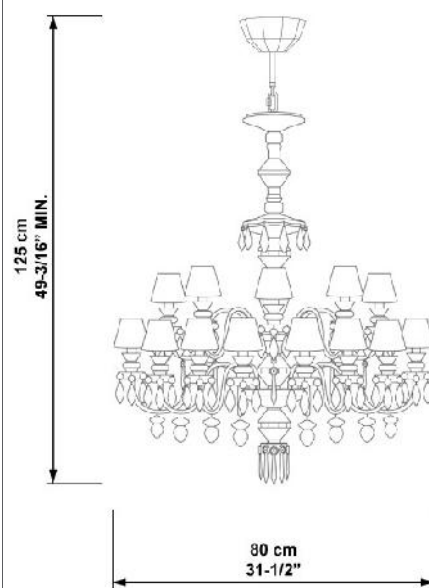

Technical data sheet

CE: Ref 01023916 - UPC/EAN 737859239168
UK: Ref 01023916 - UPC/EAN 737859239168
US: Ref 01023917 - UPC/EAN 737859239168
JP: Ref 01023918 - UPC/EAN 737859239168

Description:

Belle de Nuit - Chandelier 40 lights - silver
Belle de Nuit - Chandelier 40 luces - Plata

Collection:

BELLE DE NUIT

Mounting:

Chandelier

Environment:

Chandelier entirely made of porcelain. Made in different finishes to match all decorative ambiances. Not very heavy to simplify its installation. Bespoke measures available under request.

Installation and assembly:

Follow instructions of the installation guide

Electrical characteristics:

Max. Power: 40 x 18W
Tension: CE-UK: 220/240VAC US-JP: 100/125VAC
Frequency: 50/60Hz
 Dimmer not included / LED bulb non dimmable

Recommended Bulb

Bulb not included	Bulb reference
CE: 40 x G9 Led 3W 220V (190Lm)	01089407
US: 40 x G9 Led 3W 110V (190Lm)	

Certificates:

CE, SASO
UL

Physical characteristics:

1 Box / 140 x 119 x 119 cm / 1,983 m3
 1 Box / 55 x 46 3/4 x 46 3/4 inches / 120206 in3
 Gross weight 129,6 kg. / Net weight 27,36 kg.



LLADRÓ BdN - Chand.

Esta luminaria es compatible con bombillas de clases energéticas:

A++
A+
A
B
C
D
E

874/2012 